

---

***e-01*** *Reddy*  
*MULTI DISPLAY CONTROLLER*

**Instruction Manual**

---

***Reddy***

## **1. Important Information**

Please read this instruction manual carefully and proceed with the installation **ONLY** if you fully understand this manual. Make sure to pay close attention to all the "Important!", "Warning!" and "Caution!" messages throughout the manual.

### **Important!**

- This product is legal for sale or use in California only on vehicles which may never be driven on a public highway.
- This product is only for vehicles with 12V (battery) systems.

### **Warning!**

- Installation and tuning of this product should only be performed by a trained specialist who is very familiar with the automobile's mechanical, electrical and fuel management systems. If installed by an untrained person, it may cause damage to the unit as well as the vehicle.
- When mounting this product in the vehicle, be sure the unit does not interfere with the driver's view and normal operation of the vehicle.
- When using soldering iron and other tools for installation, be sure you read and understand the tool's user manual first. Misuse of these tools may cause injuries.
- When working on the electrical wires, make sure to disconnect the negative terminal side of the battery on the vehicle.
- When increasing the boost, be sure not to overboost. Overboosting may cause damage to the engine.
- Be sure to find out what the safe boost pressure is for your vehicle.
- GRReddy Performance Products, Inc. is not responsible for any engine damage caused by overboosting (increased boost).
- Never tune the e-manage while the vehicle is moving.
- Never tune the e-Manage on public highway. This may be dangerous to you as well as others on the road.
- When tuning and operating the vehicle in a garage, be sure that the garage is equipped with a proper ventilation system.
- After installation and tuning, be sure to clean up everything that would interfere with the driver. Wires, tools and/or communication cable may interfere with the driver and may cause accidents.

## **Important Information**

### **Caution!**

- Improper tuning of the e-Manager may cause damage to the engine.
- GReddy Performance Products, Inc. will not be responsible for any damage caused by improper installation or tuning.
- Tuning should be performed only by a experienced technician who fully understands the vehicle's fuel management and ignition timing requirement for the engine being tuned.
- Always use a proper air/fuel ratio meter when tuning the e-Manager.
- Installation of this product requires modification of the vehicle's electrical system.
- When making wire connections, be sure to remove the key from the ignition, and disconnect the negative terminal of the battery.
- Never short out the system. It can damage the unit as well as the vehicle's electrical system.
- Read and fully understand the wiring diagram before making any wire connection.
- When connecting the connector, push it in all the way until you hear them click in together.
- The communication cable is not a repairable item, so please take care of it. When disconnecting from the PC (laptop), pull holding the connector. Never pull on the cord.

# 2. Parts List

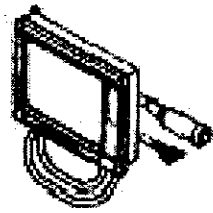

Display unit



Controller

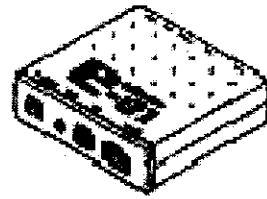

Center unit

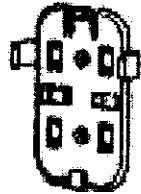

Controller holder



Display base



Display bracket



Power harness



1/4 Cap bolt



Double sided tape



Hex wrench (3mm)



Hex wrench (5mm)



M4 CAP bolt x2  
M4 nut x2



SD card

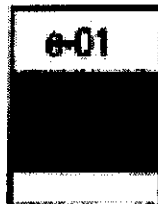

Instruction Manual

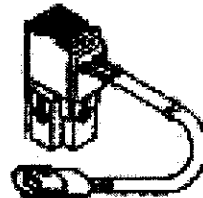

Valve unit

## 2: Parts List

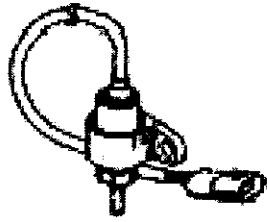

Pressure sensor



Valve unit harness  
(2.5m)



Pressure harness  
(2.5m)



6ø Hose fitting x2



Hose clamp



Three way fitting



Rubber washer



4ø Hose (1m)

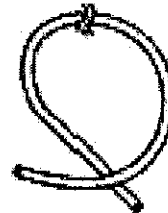

6ø Hose (1m)



M4 Bolt



M6 Bolt x2



Valve bracket

### Important!

The Display unit is packaged with the SD card already inserted.

### Tools required for installation:

- Voltage tester
- Pliers
- 10mm wrench
- Electrical tape
- Wire cutters
- Screw drivers (+,-)
- Solder and Soldering iron
- Zip ties

### **3. Product Features**

- The Display unit features a large LCD with EL backlighting.
- Three large easy to read data can be displayed in real time; such as boost pressure, rpm, etc.
- Air/fuel ratio, throttle position and vehicle speed may be displayed with the use of an optional Signal harness (sold separately).
- The GReddy Warning gauge data can be displayed with the use of an optional data link cable (sold separately).
- Built-in Warning feature for all input signals; such as boost, rpm, etc.
- Link up to e-Manage to tune and save using Standard A/B USB cable (available through any computer supply retailer).
- Able to record up to 3 hours of data and play back on the display.
- Controls boost up to  $3\text{kg/cm}^2$  (Depending on the turbo system). Select from Auto and Manual boost mode to boost up to a desired pressure.
- Boost pressure may be adjusted at different rpm points to achieve consistent boost levels.
- Uses compact high volume solenoid valve.
- Uses high quality pressure sensor.
- Able to lower the boost pressure when the warning feature is activated.
- Boost pressure may instantly be increased by using the Over Take Boost feature. This feature can be used with the Optional Remote Switching System (sold separately).

#### **Important!**

Standard A/B USB cable is required in order to link the e-01 to the e-Manage unit. This is available at any computer supply retailer.

## Before Installation

- Make sure the engine has cooled down before working under the hood.
- Take the key out of the ignition switch and disconnect the negative terminal of the battery.
- Before mounting the Valve unit and the Pressure sensor, be sure the supplied vacuum hose is long enough to reach them.
- Locate the actuator/waslegate, factory boost controlling solenoid valve, and fuel pressure regulator or true vacuum source before installation.

## Installation Diagram

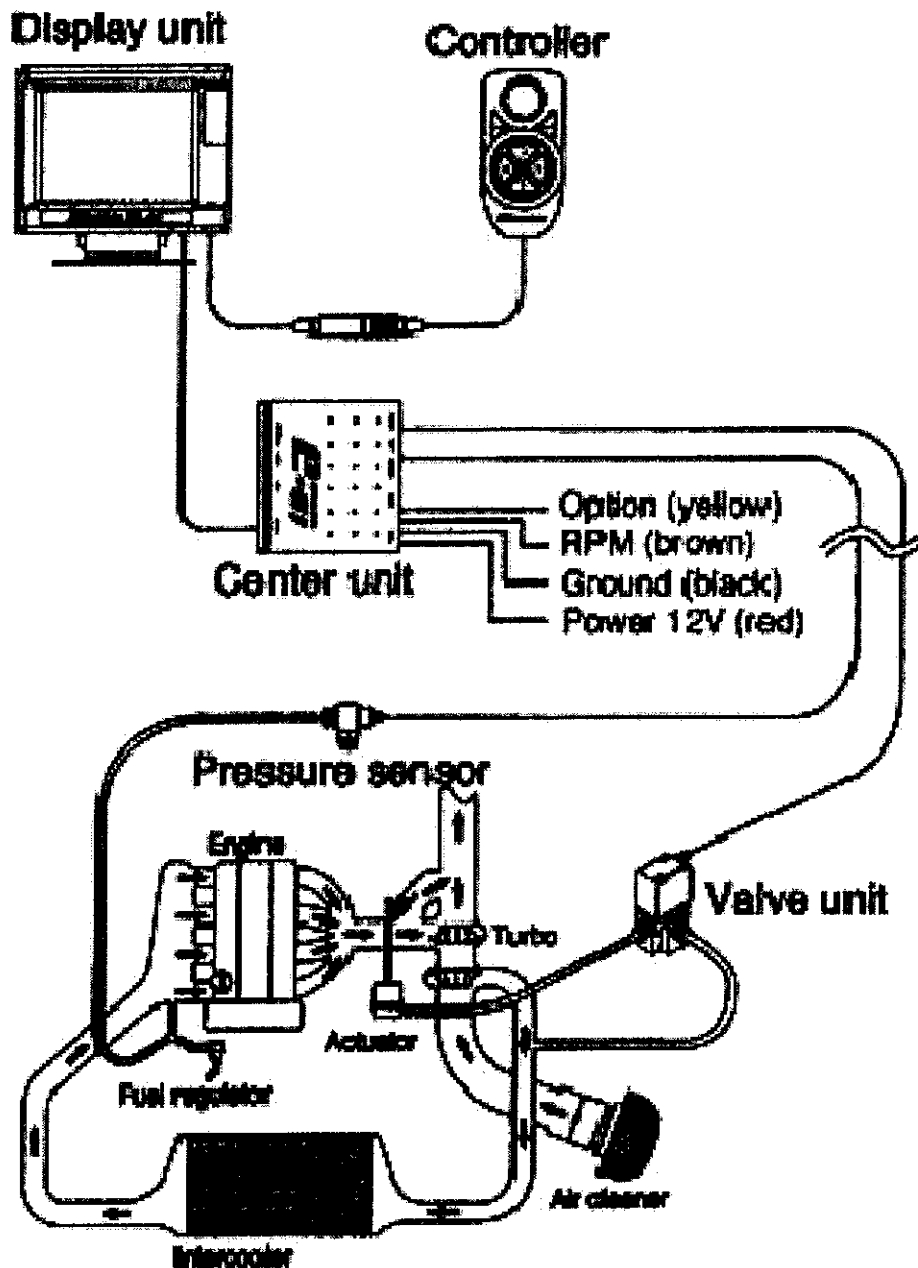

# Installation Diagram

## Diagram 1: Vehicle with factory boost controlling solenoid valve Dual Port Actuator

Disconnect the connector and the vacuum lines off from the solenoid valve and plug up the all the vacuum ports.

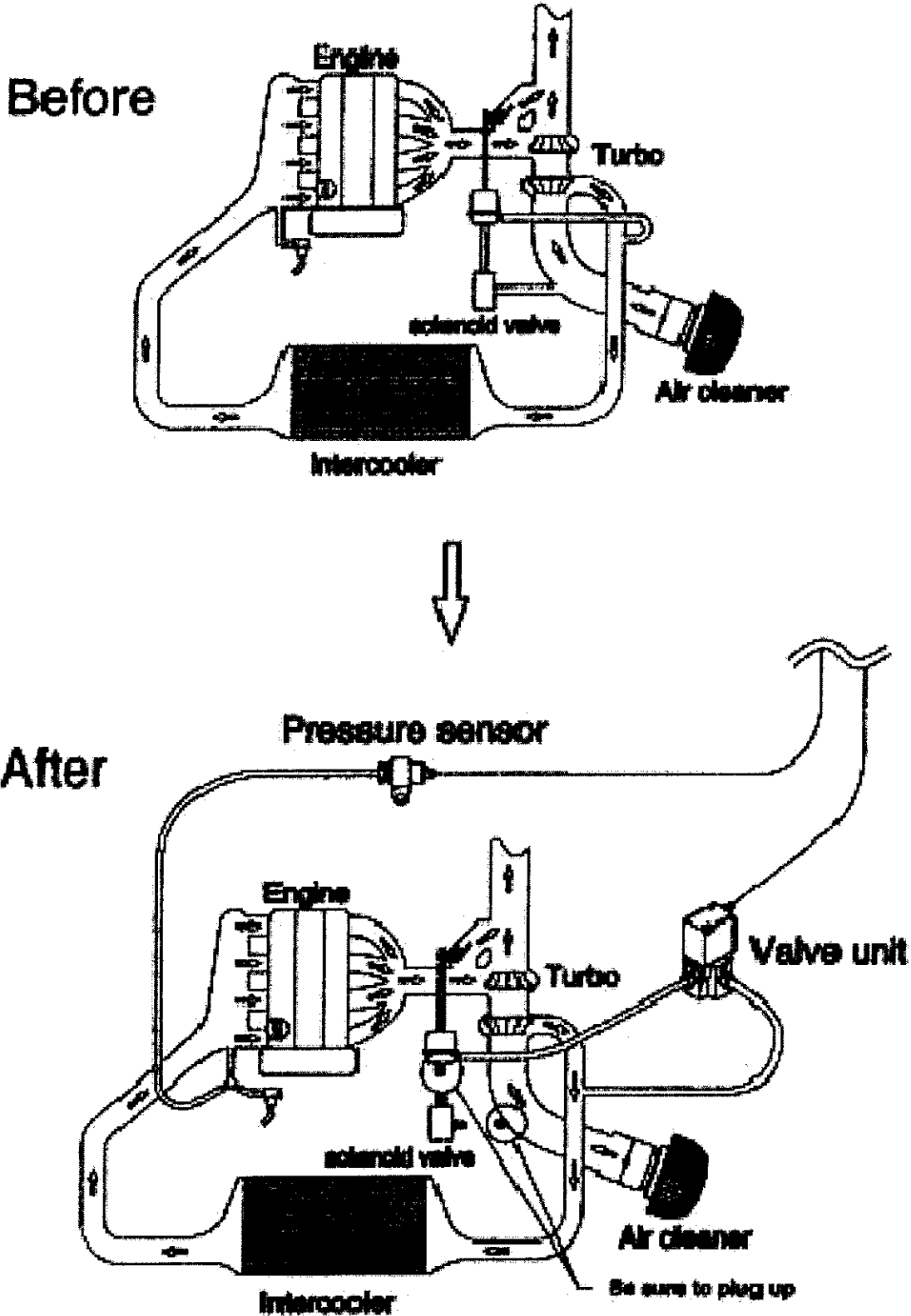



# Installation Diagram

**Diagram 2: Vehicle with factory boost controlling solenoid valve  
Single port actuator**

Disconnect the connector and the vacuum lines off from the solenoid valve and plug up the all the vacuum ports.

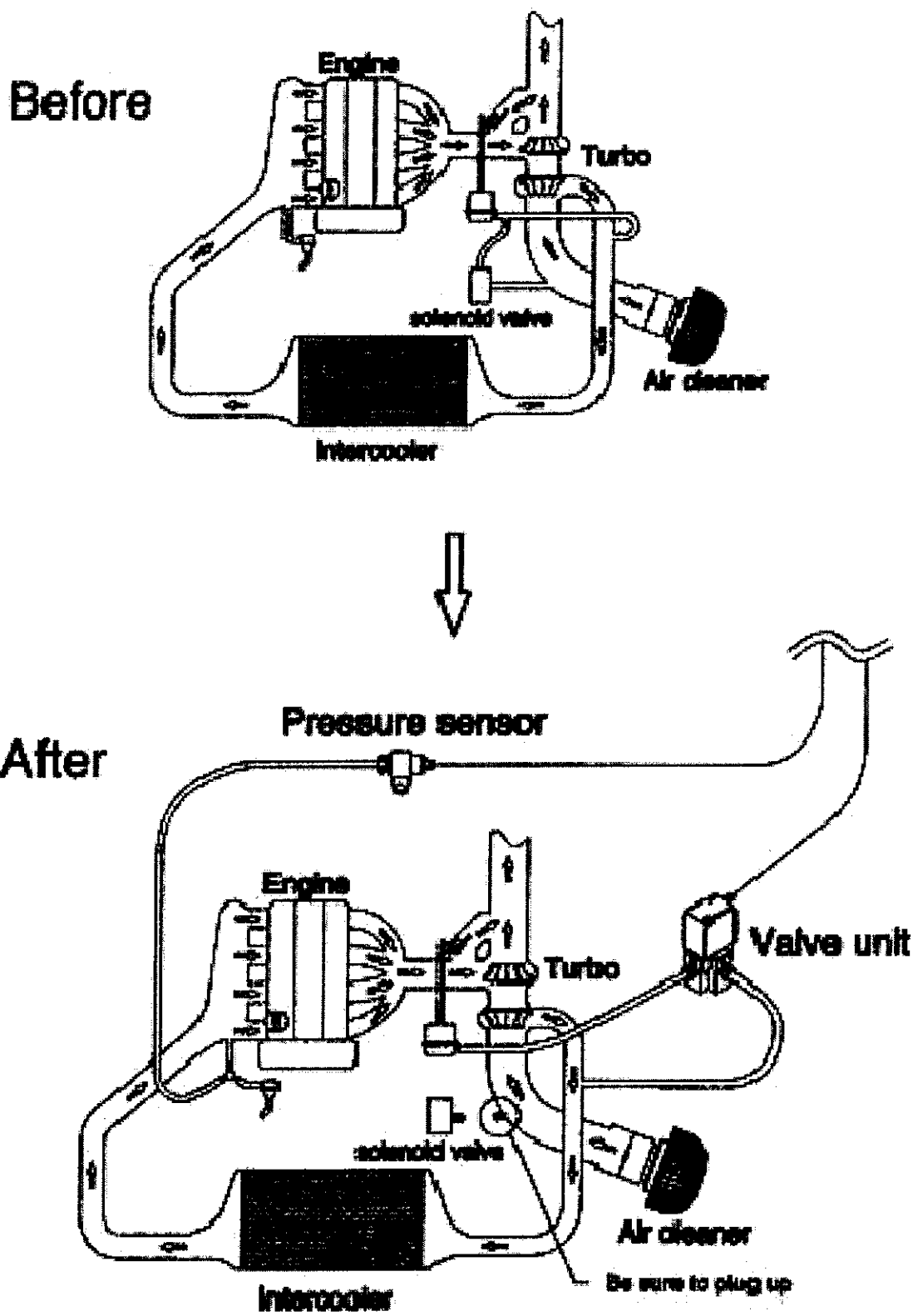

# Installation Diagram

## Pressure Sensor Installation

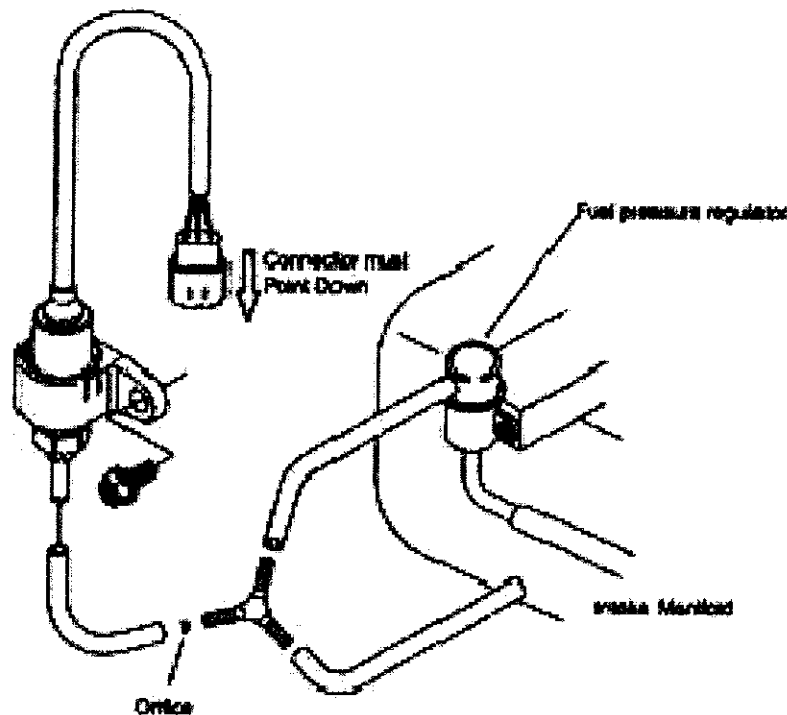

- (1) Mount the Pressure sensor to the body near the fuel regulator using the supplied bracket and bolt.
- (2) Cut the vacuum line on the fuel regulator and install the supplied three way-fitting.
- (3) Place the supplied orifice to the side that will connect the sensor and connect the 4e Hose from the three way fitting to the sensor.

### Important!

- Make sure that the Sensor connector is pointed down as shown in the diagram above.
- Make sure that the sensor is securely mounted on the body.
- Avoid mounting the sensor in the hot area or where it can get wet.
- Toyota's JZ engines and Mitsubishi's 4G63 engine have fuel pressure-controlling solenoid valves. For these vehicles, make sure to get pressure from the line between the intake manifold and the solenoid.
- Make sure to secure the 4e Hose with zip ties.

## Installation Diagram

### Valve Installation (Actuator type)

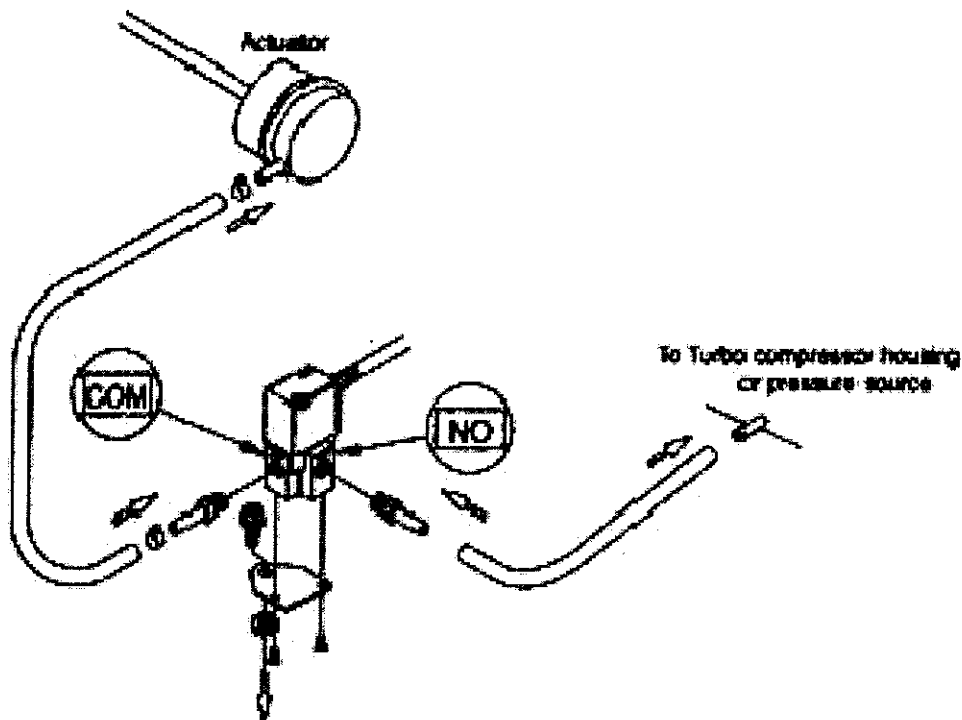

- (1) Remove all the plastic plugs from the Valve unit
- (2) Install the 6ø Hose fitting on to "NO" and "COM" port on the Valve unit.
- (3) Install the Valve bracket using the supplied M4 bolts. Then, secure the Valve assembly to the body using the supplied M6 Bolt and Rubber washer.
- (4) Disconnect the vacuum hose connecting the compressor housing of the turbo to the actuator at the actuator side and connect it to the "NO" side of the Valve unit.
- (5) Connect the "COM" port to the actuator using the supplied 6ø vacuum hose.

#### Important!

- It is very important that the Rubber washer is used when mounting the bracket to the body.
- Mount the Valve unit in a cool area where the unit will not get hot or wet.
- Secure all the Vacuum connections with hose clamps.
- When routing the vacuum hoses, make sure not to kink or twist the hoses.
- Make the hoses as short as possible.
- It is normal for the Valve unit to make a clicking sound when it is operating.

## Installation Diagram

### Valve Installation (External wastegate type)

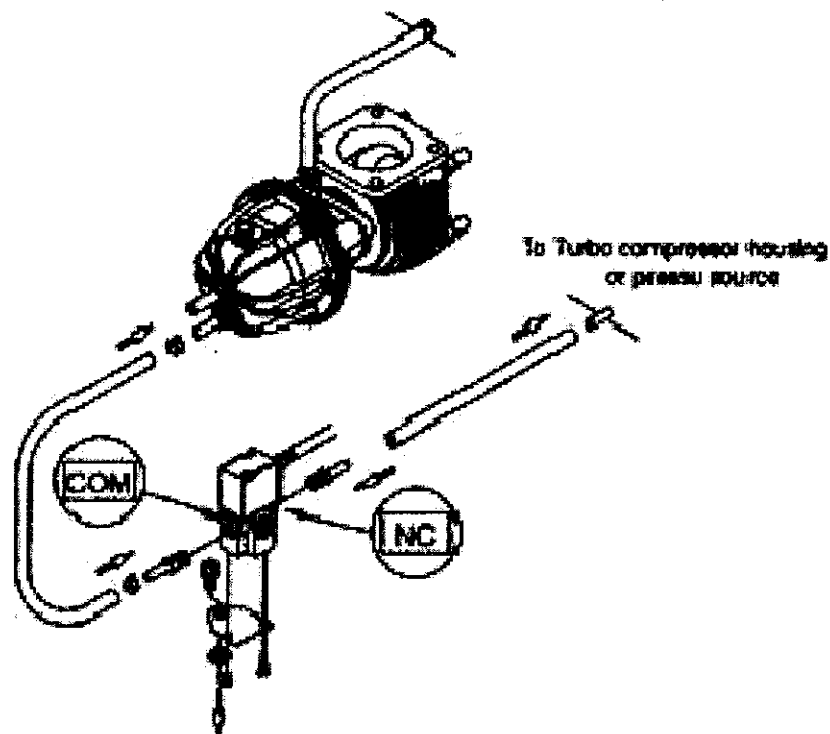

- (1) Install the 6ø Hose fitting onto "CN" and "COM" port on the Valve unit.
- (2) Install the Valve bracket using the supplied M4 Bolts. Then, secure the Valve assembly to the body using the supplied M6 Bolt and Rubber washer.
- (3) Install a 6ø Hose fitting (sold separately) on the top of the wastegate.
- (4) Connect the 6ø Hose fitting that was just installed to the "COM" port of the valve unit using the supplied 6ø Vacuum hose.
- (5) Connect the "NC" port to a good pressure source such as the Compressor housing of a turbo using the supplied 6ø Vacuum hose. (It is ok to tap into the same line that is going to the bottom port on the wastegate)

#### Important!

- It is very important that the Rubber washer is used when mounting the bracket to the body.
- Mount the Valve unit in a cool area where the unit will not get hot or wet.
- It is normal for the Valve unit to make a clicking sound when it is operating.

## Wiring Procedures

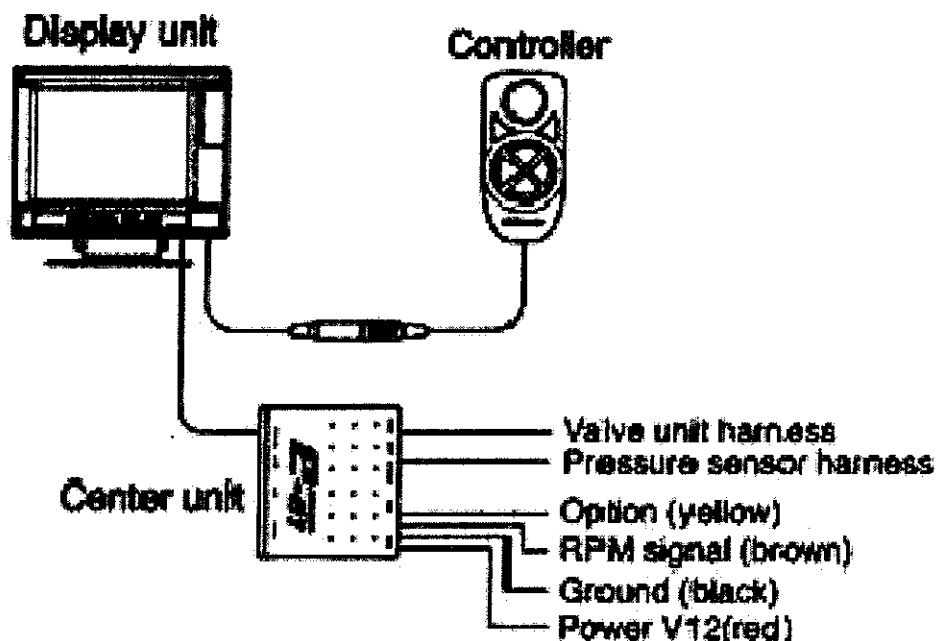

- (1) Connect the Pressure sensor harness and the Valve unit harness to the Valve unit and the Pressure sensor that was installed in the engine compartment.
- (2) Route the Pressure sensor harness and Valve unit harness through the firewall in to the passenger compartment and connect them to the center unit.
- (3) Connect the Controller to the Display unit, then connect the Display unit to the Center unit.
- (4) Reconnect the battery and find 12V Ignition source with a tester.
- (5) Ground the black wire to the body. When grounding to the body, sand or grind off any paint or rust to ensure good contact.

### Important!

- Connect the brown wire in the Power harness to the ECU rpm signal wire. The boost controller will still operate with out this connection, but the rpm offset feature will not work.
- Yellow wire in the Power harness is an optional output signal, used for warning light and/or buzzer. 14V-350mA

## Mounting the Display Unit

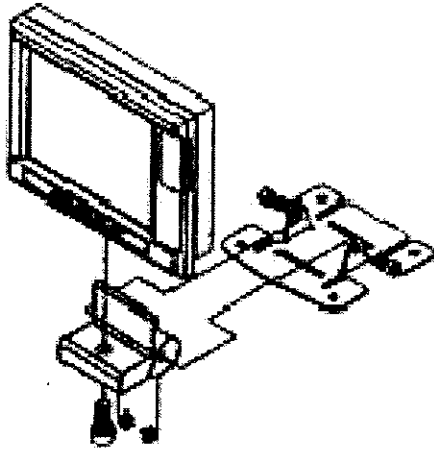

- Mount the Display unit using the supplied base, bracket and double-sided tape.
- Mounting surface must be free of dirt and oil.

### Caution!

- For safety, once the mounting location is determined, secure the bracket using couple of screws so that the unit will never fall off.
- Never install the display unit in front of the airbag system. The unit will fly off when the air bag deploys. This can be very dangerous.

### Important!

- When mounting this product in the vehicle, make sure the unit does not interfere with the driver's view and normal operation of the vehicle.
- Never remove the SD card out while the unit is turned on. This can damage the saved program in the card.

## 4. After Installation Inspection

- Reinstall all the parts that were removed during the installation of this product.
- Reconnect the negative terminal of the battery.
- Make sure that all harness and hoses are secured and properly connected and routed.
- Improper connection and routing of the harnesses and hoses can damage the unit and the sensors, which can cause engine damage.
- GReddy Performance Products, Inc. is not responsible for any engine damage caused by improper installation.

## 5. Display unit and Controller Functions

### Controller features

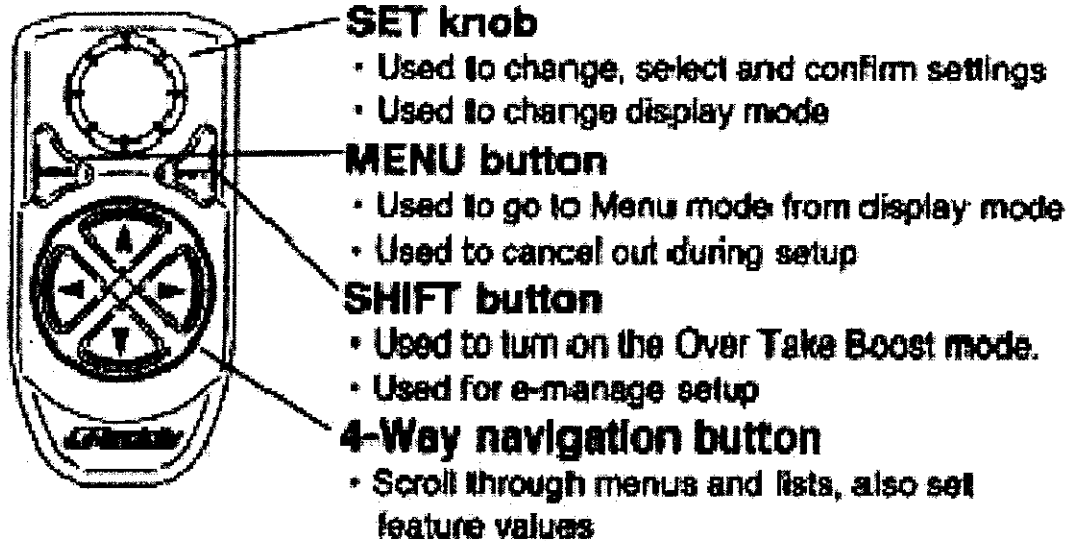

### Menu screen

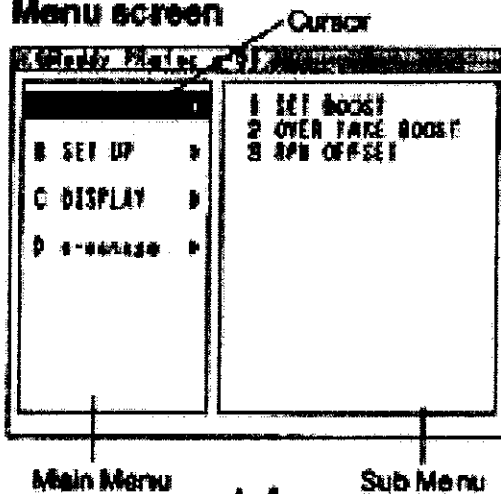

MENU button      SET Knob

### Setup Screen

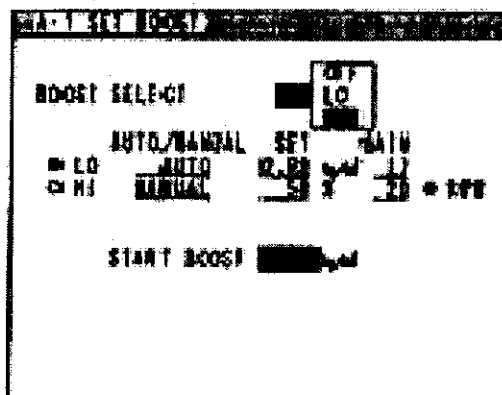

- (1) Basic Boost setup**  
To set each feature, scroll down and select the desired Main menu and Sub-menu and make the changes in the Setup screen.
- (2) Menu screen**  
In the Menu screen move the cursor using the 4-way Navigation button and push the Set knob to select each feature.
- (3) Setup Screen**  
In the Setup screen, use the 4-way Navigation button to move the cursor. To change the value or setting, turn the SET knob to change and press the SET knob to confirm the changes.
- (4) Press the MENU button to return to the Menu screen from setup screens.**

## 5. Display unit and Controller Functions

### Controller features

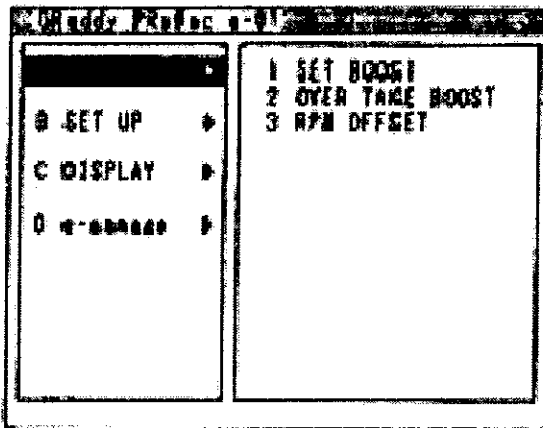

#### A BOOST

Used to set up boost settings

#### B SET UP

Used to change the initial setting, Warning and Peak Hold features.

Also used to setup the optional signal harness and Warning gauges when installed with this unit.

#### C DISPLAY

This feature can display 3 input signals at real time such as boost, rpm and Throttle position data. There are 4 different display formats to choose from, Digital, Graph, Gauge and Bar graph.







#### D e-manage

Used to program the e-manage settings.

\*This feature is only for vehicles equipped with e-manage

### Title display description



-  ---- displays during recording data
-  ---- displays during data playback
-  ---- flashes when the warning feature is activated
-  ---- displays during Over Take Boost mode
-  ---- displays during learning in the Auto Mode
-  ---- displays while the unit is locked
-  ---- displays when error has occurred.



## 5. Display unit and Controller Functions

### Short cut

By pressing the MENU button with the up or down key of the 4-way navigation button, you can scroll to A BOOST, B DISPLAY or C e-manage without going through the main menu screen.

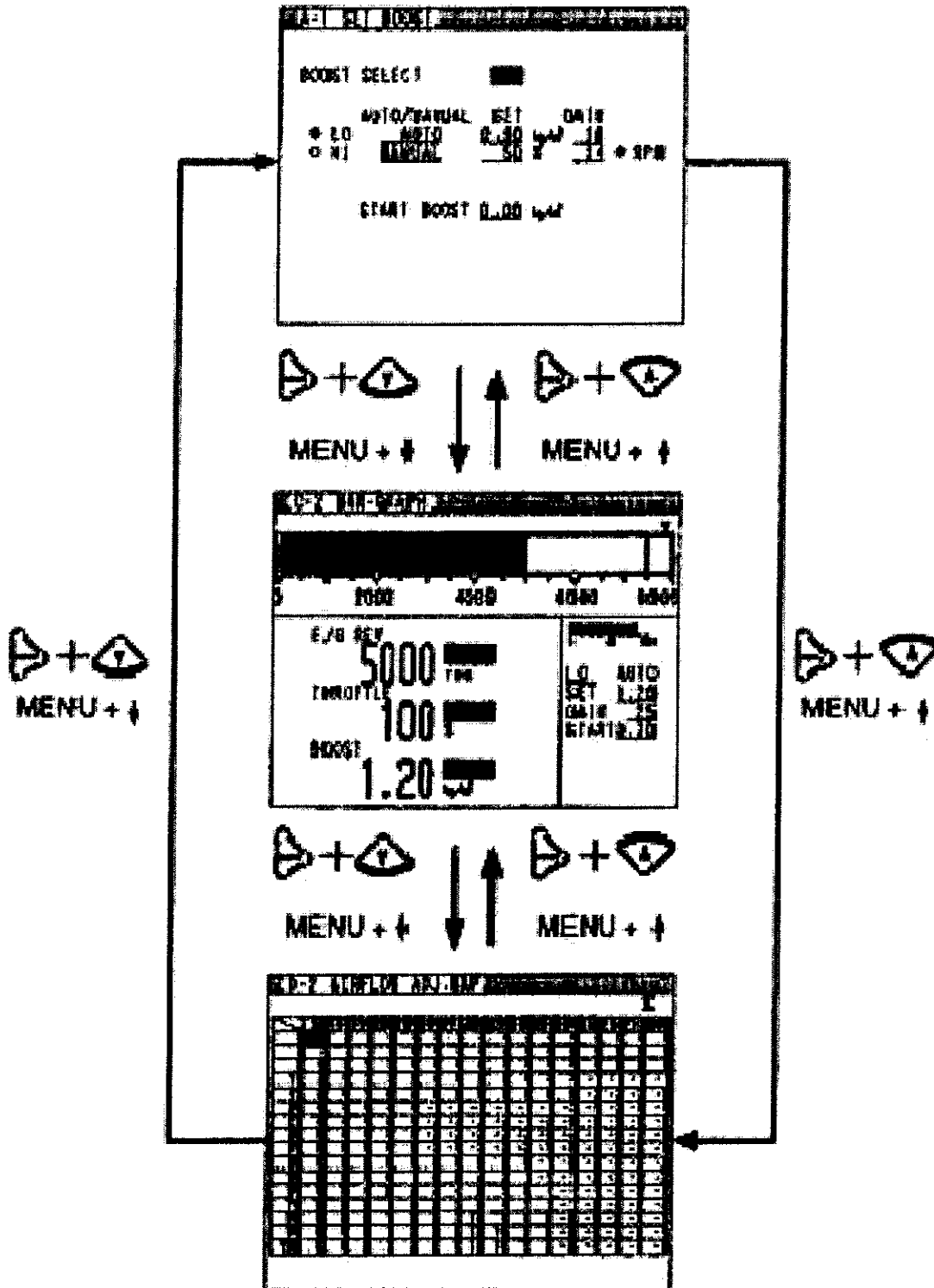

## 6. Initial Setting

### CAR SELECT (B-1)

When installed for the first time, the unit will automatically go to this Initial Setting mode. The boost controller feature will still operate without performing this setup, but without confirming the rpm, throttle position and vehicle speed signal, the RPM OFFSET feature will not operate.

CAR SELECT	
NUMBER OF CYLINDERS	4
THROTTLE SENSOR TYPE	NORMAL
SPEED METER PULSE	2P
UNIT SELECT	mmHg
[OK]	

#### 1. NUMBER OF CYLINDERS

Select the number of cylinders the vehicle is equipped with.

For rotary engines, select 4 for 2 rotor and 6 for 3 rotor engines.

\* This setting is required to display rpm at real time or to use the RPM OFFSET feature.

#### 2. THROTTLE SENSOR TYPE

**NORMAL** --- This type increases the throttle signal voltage as the throttle opens.

**REVERSE** --- This type decreases the throttle signal voltage as the throttle opens.

Select **NORMAL** or **REVERSE** sensor type

#### 3. SPEED METER PULSE

**16P** -- For Nissan Y32 Gloria/Cedric (only available in Japan)

**8P** -- For Nissan Y32 Cerna (only available in Japan)

**2P** -- For all other Nissan vehicles

**4P** -- For all other Japanese vehicles

Select the corresponding Pulse setting

#### 4. UNIT SELECT

kPa

kg/cm<sup>2</sup> (1 kg/cm<sup>2</sup> = 98.0665kPa)

mmHg (1 mmHg = 0.133322kPa)

bar (1 bar = 100kPa)

psi (1 psi = 6.895kPa)

# A-1 SET BOOST

## A-1 SET BOOST

### Boost setting

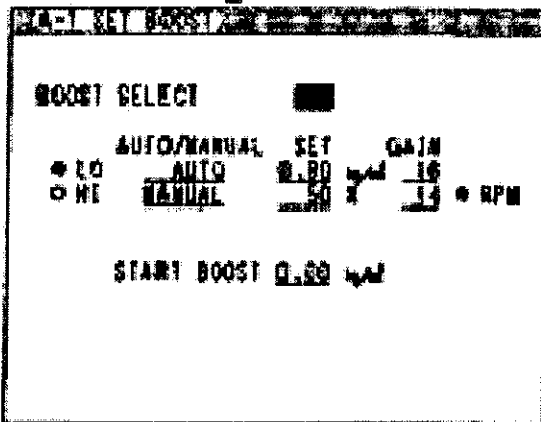

Set the boost controller features.

### 1. BOOST SELECT

Select from 3 settings

Hi High boost mode

Lo Low boost mode

OFF Stock boost mode

### 2. AUTOMANUAL & SET boost

**AUTO** - - - Auto learning mode. This feature will automatically program the e-01 for best boost response and consistent boost curve. See next page for the learning procedure. Select this mode and input the desired boost setting.

**MANUAL** - - - Manual input mode. This feature will allow the user to input a boost setting for a custom boost curve. This feature requires the user to input boost controller solenoid duty cycle value and monitor the boost in display mode to see how much boost is increased at the inputted duty cycle. 0% will be same as base boost or boost controller turned OFF. 100% will be same as disconnecting the wastegate signal line. Select this mode and input the desired solenoid duty cycle.

- To use the boost controller right away, select the AUTO mode and follow the learning procedure.
- If you select the MANUAL mode, input the SET, GAIN, START BOOST setting to achieve the similar boost control as using AUTO mode.

### 3. START BOOST

This feature is used to improve the turbo spool up by holding the signal to the wastegate which holds the wastegate completely closed until the boost reaches the Start Boost value. If the value is too close to the SET Boost value, the boost will over shoot (boost spike).

Set this feature 20kPa (0.2kg/cm<sup>2</sup>, 2.8psi) less than the SET boost value.

### 4. GAIN

This feature is used to stabilize the boost by changing the control valve's duty cycle. The larger the value, the faster the response will be and the lower it is, the response will be slower. If the value is set too high, the boost will overshoot (boost spike).

Select this mode and input the desired solenoid duty cycle.

## A-1 SET BOOST

### Learning Procedure (only for AUTO mode)

This step will program the correction value necessary to achieve the desired boost setting.

- (1) Select AUTO mode and input the target boost value. AUTO.P will indicate phase 1 in the upper right corner of the display.
- (2) Make a full throttle run in 3rd or 4th gear to go into boost. It will run stock boost to confirm the base boost. Then it will gradually go up to the target boost value. As soon as the boost nears the target boost value, release the accelerator.
  - If the vehicle's stock boost is not stable (not holding consistent boost pressure), it is possible that this feature would not be able to confirm the base boost. In this case, use the MANUAL mode.
- (3) Once the target boost value is confirmed, the AUTO.P will start to flash indicating phase 2.
- (4) Make another full throttle run in 3rd or 4th gear to go in to boost. As soon as the boost reach consistent target boost, release the accelerator.
- (5) Once it confirms consistent target boost, AUTO.P will turn off. This completes the learning procedure.

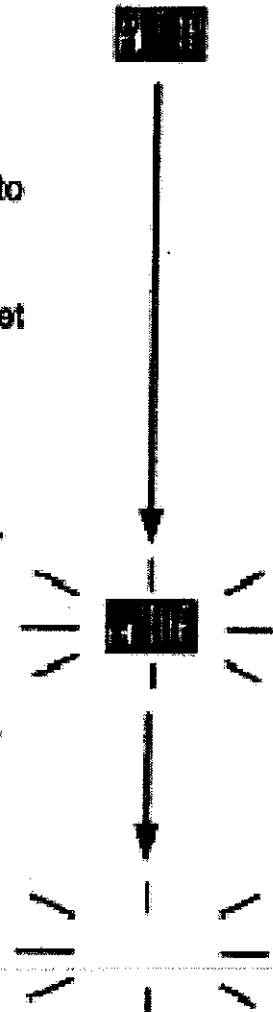

### Important!

- Always perform the learning procedure at full throttle.
- It is possible that AUTO mode might not program properly due to turbocharger size, wastegate's capacity and extreme exhaust pressure.

- Each SET boost setting will initially require learning.
- Relearning is required when the GAIN setting is changed. This will set the unit to phase 1 mode with AUTO.P lit.
- If the Boost select setting (HI/LO) is changed or ignition is turned off during phase 2 (AUTO.P Flashing), it will return to phase 1

## A-2 OVER TAKE BOOST

### Over Take Boost setting

This feature is used to boost over the SET boost setting. The kept high boost mode that can be turned on for a set amount of time or on constantly.

\*See page 35 for operation of this feature.

A-2 OVER TAKE BOOST	
TIME	■
DUTY RATE	0
AUTO/MANUAL	AUTO
SET	1.50 $\omega$
GAIN	18
START BOOST	2.00 $\omega$

#### 1. TIME

1-99 - - - Input Over Take Boost operation time.

PS - - - Select this feature to turn on the Over Take Boost mode only while holding down the SHIFT button.

$\omega$  - - - - Select this feature to select between the SET Boost level or Over Take Boost level with the SHIFT button.

#### 2. DUTY RATE

This feature can adjust the rate of the boost change when the Over Take Boost is turned on to avoid boost spike.

The higher the number, the slower the change rate gets.

(Standard setting should be 0. If boost spike occurs, increase the duty rate)

#### 3. AUTO / MANUAL, SET, GAIN, START BOOST

Follow the same set up procedure as the SET BOOST. see page 18.

- Learning is required if Over Take Boost is set to a value that is not learned yet.
- The optional Remote Switching System (sold separately) can be used to select the SET Boost or Over Take Boost.



## B-1 CAR Select

Initial setting can be changed. See Initial Setting on page 17.

## B-2 WARNING

### Warning setting

Input warning point for the boost and external input signal to turn on the LED and alarm.

Set the Limiter to turn down the boost when the pressure exceeds the warning point.

The screenshot shows a menu titled "WARNING" with the following options and settings:

- LED ALARM: ON
- BOOST LIMITER: 0.80 (with a cursor) and -1.00 (with a cursor)
- EXT INPUT: AND
- External input channels: AN CR1, AN CR2, PL CR1, PL CR2 (all are unchecked)

#### 1. LED

Select ON, OFF, Flash1 or Flash2.

#### 2. ALARM

Select ON, OFF, Alarm1 or Alarm2.

#### 3. BOOST

Input the boost warning point.

#### 4. LIMITER

Input a rate to decrease the boost pressure when the boost exceeds over the warning point.

Selecting OFF will turn off the Limiter feature.

#### 5. EXT.INPUT

Select the external input channels to turn on the warning feature.

The warning point will be set in the Ext. Input signal setup screen.

Select OFF, AND or OR.

AND - - - When both Boost and Ext. input signal reaches the warning point, the LED and Alarm will turn on.

OR - - - When either Boost or Ext. input signal reaches the warning point, the LED and Alarm will turn on.

## B-3 PEAK HOLD

### PEAK HOLD setting

This feature can store the highest data recorded and display the data in the Display mode. The Peak Hold type can be selected.

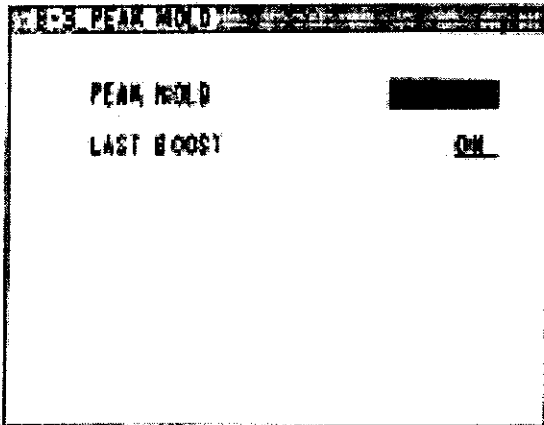

#### 1. PEAK HOLD

The Peak Hold type can be selected.

PEAK - - - - - Display the highest boost monitored.

Constant - - - Display the highest constant boost monitored.

Select PEAK or CONSTANT setting.

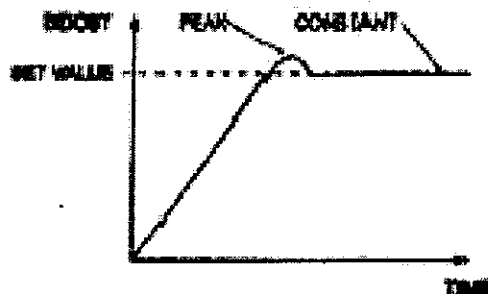

#### 2. LAST BOOST

This feature will display the last highest boost monitored for 3 seconds and reset to display the next run.

Select ON or OFF setting.

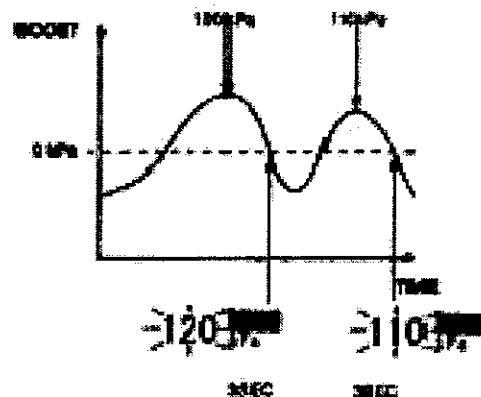



## B-4 ANALOG INPUT

### Analog signal input

This feature is used to monitor the analog input signal with the optional External Input Signal Harness (sold separately). See page 27 for throttle input signal setup.

- Use this feature to display useful data such as Air/Fuel Ratio and throttle position.

	CH1	CH2
NAME		AK CH2
UNIT	1/16	1/16
VOLT	0.00 ~ 5.00	0.00 ~ 3.00
CONVERSION	10.00 ~ 30.0	0.00 ~ 10.0
WARNING LOCATED	20.0 1/16	10.0 1/16

### 1. NAME

Input name to label each input signal channel. Input up to 8 letters.

See next page for Character Input procedure.

### 2. UNIT

Select the unit for the input signal. Select a blank space if proper unit is not one of the options.

### 3. VOLT

Input the range of the input signal (minimum to maximum voltage). Input from 0V to 16.0V at 0.01V increments.

### 4. CONVERSION

Input the conversion for the input signal (minimum to maximum voltage).

-Example-

If using a Air/Fuel Ratio that reads 10 ~ 30A/F at 0 ~ 5V, input the following;

VOLT	0.00	~	5.00
CONVERSION	10.0	~	30.0

### 5. WARNING

Input the warning point for the input signal.

### 6. LOCATED

▲ - Warning feature will operate when the input signal exceeds the warning setting.

▼ - Warning feature will operate when the input signal drops below the warning setting.

Select the Warning feature condition.



## B-4 ANALOG OUTPUT

### B-6 ANALOG OUTPUT

This feature will allow the user to clamp the optional input signal at a minimum or maximum signal value and output these signals for different purposes. Use the optional External Input Signal Harness (sold separately) and select one to use as output signal.

B-6 ANALOG OUTPUT	
<input checked="" type="checkbox"/> ANALOG	
ANALOG INPUT	AN CH1
CLAMP VOLT	5.00 V
LOCATED	=
<input type="checkbox"/> PULSE	
PULSE INPUT	EL CH1
Hz/RPM	0 - 2000
VOLT	0.00 - 5.00

#### 1. ANALOG

##### ANALOG INPUT

Select the channel to use for output signal.

##### CLAMP VOLT

Input the minimum or maximum clamp voltage.

#### Example

Set max. analog signal to 4.20V

<input checked="" type="checkbox"/> ANALOG	
ANALOG INPUT	AN CH1
CLAMP VOLT	4.20 V
LOCATED	=

#### LOCATED

▲ --- This will clamp the CLAMP VOLT value as a maximum voltage and will not output any higher signal.

▼ --- This will clamp the CLAMP VOLT value as a minimum voltage and will not output any lower signal.

- This feature can be used for Boost Limiter Cut for some vehicles.

#### 2. PULSE

##### PULSE INPUT

Select the channel to use for output signal.

##### Hz / RPM

Input the minimum and maximum frequency or rpm value.

##### VOLT

Input the minimum and maximum converted voltage value.

## B-7 THROTTLE

### THROTTLE setting

Set up this feature to display the rpm data in the Display Mode. The rpm signal can be inputted by using the optional External Input Signal Harness (sold separately) or through the e-manage unit.

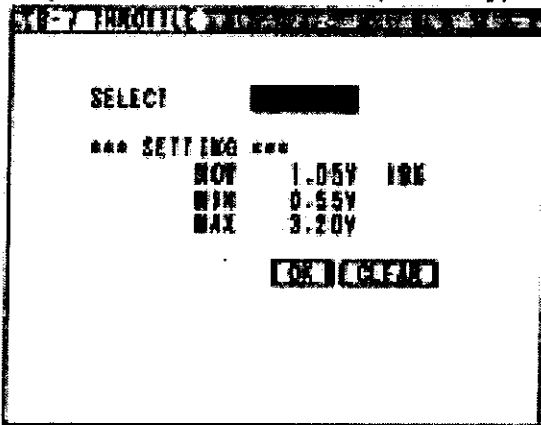

### SELECT

Select the rpm input signal source.

Select ANALOG CH1, ANALOG CH2 or e-manage

### SETTING

**NOW** - - - Throttle voltage signal and position will be displayed

**MIN** - - - Minimum Voltage when throttle is closed. (0% throttle position)

**MAX** - - - Maximum voltage when throttle is fully opened. (100% throttle position)

Program the MAX setting by turning on the ignition and holding the throttle fully opened and pressing OK to confirm.

• MIN setting will be set automatically.

- If the THROTTLE SENSOR TYPE in INITIAL SETTING is not selected properly, the rpm signal will display backwards.
- This feature will not work on a vehicle with out throttle position signal

## B-8 WARNING METER

### WARNING METER

This feature can be used to input the signal from G-Reddy Warning Gauges using the optional Data Link Cable. (sold separately)

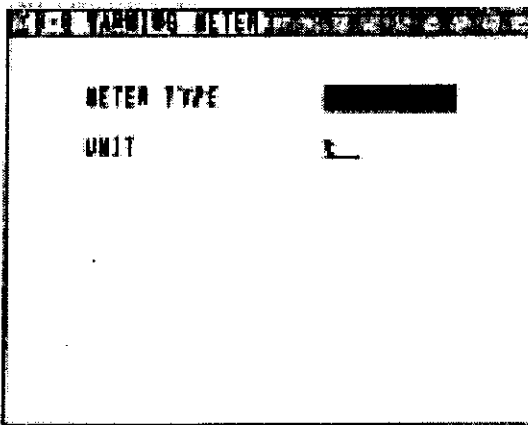

#### 1. METER TYPE

Select the meter type.

#### 2. UNIT

Select the unit for the selected meter type.

## B-9 WARNING METER

### B-9 SIGNAL CHECK

Signal check mode

Use this feature to check and make sure that the signals are inputted properly.

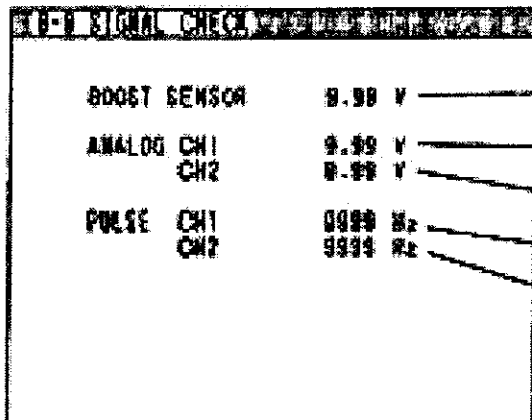

Pressure sensor voltage

Analog signal input 1

Analog signal input 2

Pulse signal input 1

Pulse signal input 2

## B-10 LCD

### LCD screen setup

Use this feature to adjust the brightness and contrast.

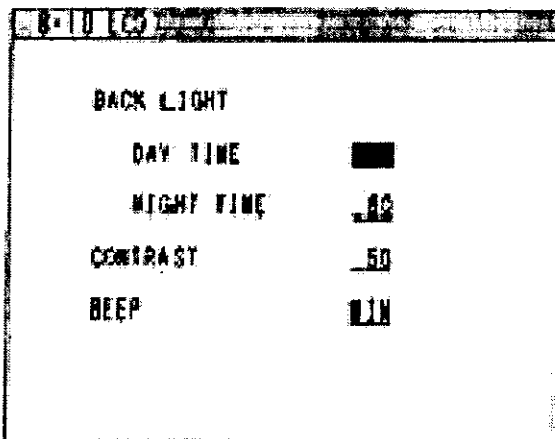

#### 1. BACK LIGHT

By using the illumination sensor, the brightness can be adjusted for daytime and nighttime.

##### (1) DAY TIME

Adjust the Daytime brightness

##### (2) NIGHT TIME

Adjust the Nighttime brightness

#### 2. CONTRAST

Adjust the contrast.

#### 3. BEEP

When the Controller button is pressed the unit makes a "BEEP" sound. Use this feature to adjust the sound level or turn off the sound.

## B-11 PROGRAM

### Program Information

Use this feature to check the version type of the Display, Center Unit and e-manage system.

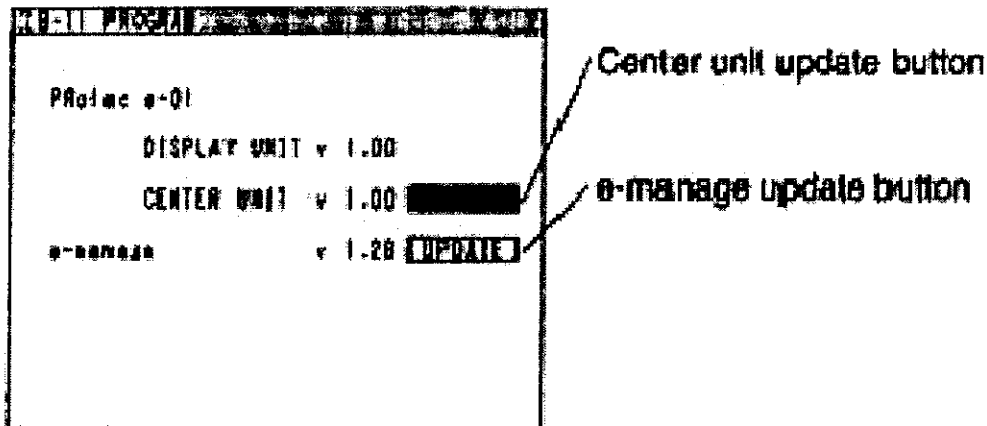

### e-manage Update (Communication program download)

- This is necessary to communicate with e-manage.
- If the unit is linked with the e-manage for the first time the download will start automatically.
- Always perform the download with the ignition "ON" and engine turned off.

- (1) If the 12 pin Ignition Harness is connected to the e-manage, disconnect it off from the unit.
- (2) Choose UPDATE and select YES to start the download. Download will take approximately 5 minutes.

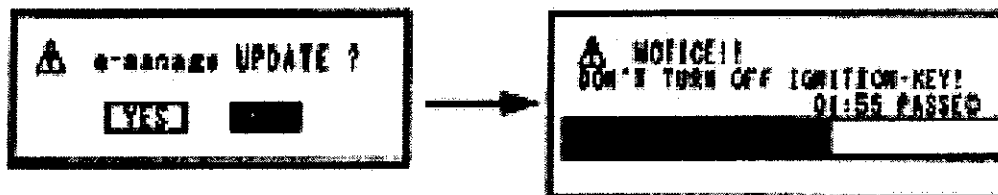

- Never disconnect the USB communication cable while updating.
- Never turn the ignition OFF while updating.
- Turning the ignition OFF while updating can put the e-manage in to limp mode. If this occurs, re-update the unit.

## B-11 PROGRAM

(3) When the download is complete, turn the ignition OFF.

**▲ UPDATE COMPLETE  
TURN OFF IGNITION-KEY**

### Important!

- Turn off the ignition and turn it back on to confirm the update.

(4) Reconnect the 12 pin Ignition harness back to the e-manage unit.

## ERROR MESSAGE

If an error occur any time during the operation of the e-01, the following message will appear:

**▲ ENGINE RPM DETECTED!  
TURN OFF ENGINE AND TRY AGAIN**

**▲ UPDATE FAILED !!**

- If the engine is running, the unit will not update. Turn the engine off and re-update the unit.

## B-12 INITIALIZE

### RESET SETTING

This feature is used to reset all of the setting and the learned data.

- To initialize e-manage, see page 53 D-11 INITIALIZE.





## C DISPLAY

This feature can display 3 input signals at real time such as boost, rpm, and Throttle position data. There are 4 different display format to choose from, Digital, Graph, Gauge, and Bar graph. HI, LO boost selection, SET BOOST, GAIN, START BOOST can be adjusted in this mode.

### ITEM SETUP

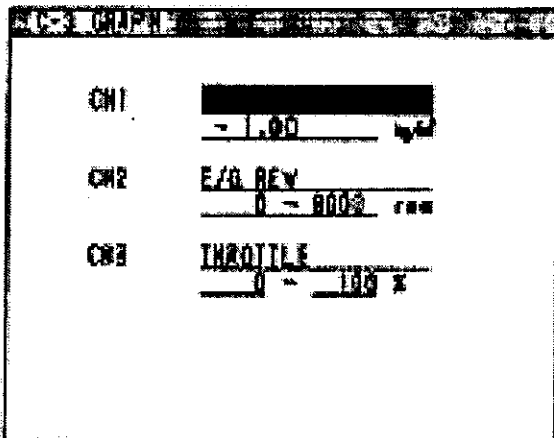

- (1) Select the data to display
- (2) Input the minimum and maximum of the data range to display.
- (3) Press the SET knob to go to Display screen

Display data list and description	
OFF	No Display
BOOST	Boost Pressure
E/G Rev	Engine rpm
AN CH1	Analog input signal channel 1
AN CH2	Analog input signal channel 2
PL CH1	Pulse input signal channel 1
PL CH2	Pulse input signal channel 2
THROTTLE	Throttle position
SOL.DUTY	Boost controller solenoid valve duty cycle
AIR FLOW INPUT	e-manage airflow meter input signal
AIR FLOW OUTPUT	e-manage airflow meter output signal
NORMAL DURATION	e-manage Stock injector duration (ms)
NORMAL DUTY CYCLE	e-manage stock injector duty cycle (%)
TOTAL DURATION	e-manage Stock injector duration (ms)
TOTAL DUTY CYCLE	e-manage stock injector duty cycle (%)
IGN. TIMMING ADJ	e-manage adjusted ignition timing

## C DISPLAY

### Important!

- The e-manage data in display data list can be selected but, the data will not display without the e-manage linked.
- Setup the Parameter in e-manage to display the e-manage data.

### Moving the Channels

Channel	Item	Value
CH1	BOOST	2.00
CH2	E/O MEY	0
CH3	INNOVILE	100

### -EXAMPLE-

to swap CH2 item in to CH1 spot,

- (1) Move the cursor and hi-light CH2.
- (2) Hold down the SHIFT button and press up button on the 4-way navigation button.

•To move to CH3, hold down the SHIFT button and press down button on the 4-way navigation button.

Channel	Item	Value
CH1	E/O MEY	0
CH2	BOOST	2.00
CH3	INNOVILE	100

## C DISPLAY

### Changing Setting in display mode

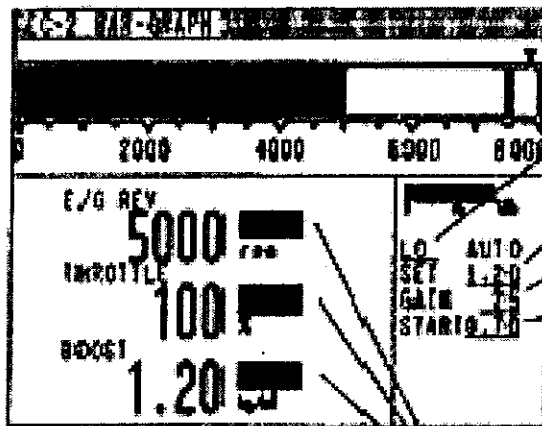

Press the SET knob  
HI / LO  
↓ Press the SET knob  
SET  
↓ Press the SET knob  
GAIN  
↓ Press the SET knob  
START BOOST  
↓ Press the SET knob  
Cursor will disappear

PEAK

HI, LO boost selection, SET BOOST, GAIN, START BOOST can be adjusted in any of the Digital, Graph, Gauge, and Bar graph display mode.

Press the SET knob to move the cursor to the target setting.  
Turn the SET knob to make changes.  
Press the SET knob again to confirm the setting.

\* Press the MENU button to cancel at any time.

### PEAK HOLD Reset

To clear the stored Peak Hold data, hold down the up button on the 4-way navigation button for 2 seconds.

### LOCK Feature

This feature is used to lock all the settings to prevent any problems. To lock, press down the MENU button and SHIFT button for 5 seconds.

Repeat the same procedure to unlock.

Lock feature can only be set in the Display mode.

When the unit is locked, the message shown is displayed and the "LOCK" will appear in the upper right hand corner of the title bar.



# C DISPLAY

## OVER TAKE BOOST operation

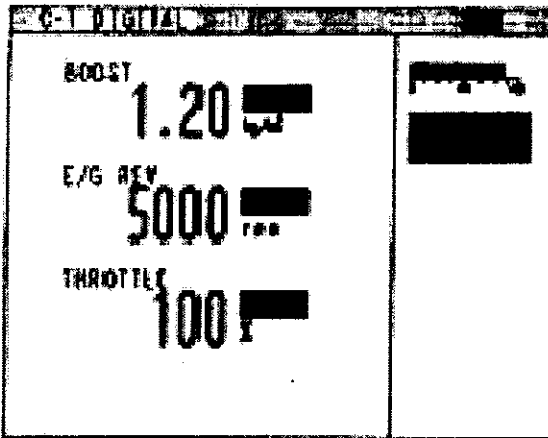

- (1) Set up the OVER TAKE BOOST feature. See page 20.
- (2) While in Display mode, press the SHIFT button to go to OVER TAKE BOOST mode.

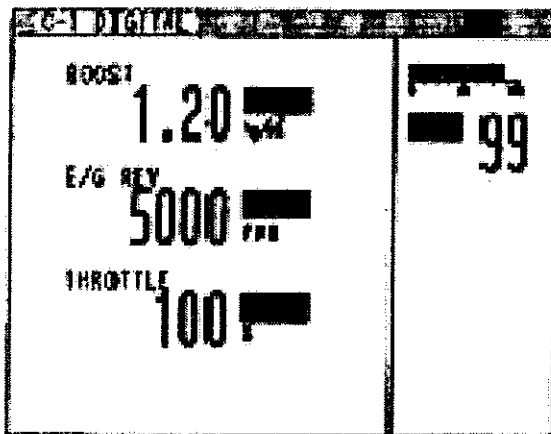

- How to scroll through 4 different Display types  
Use LEFT and RIGHT button on the 4-way navigation button

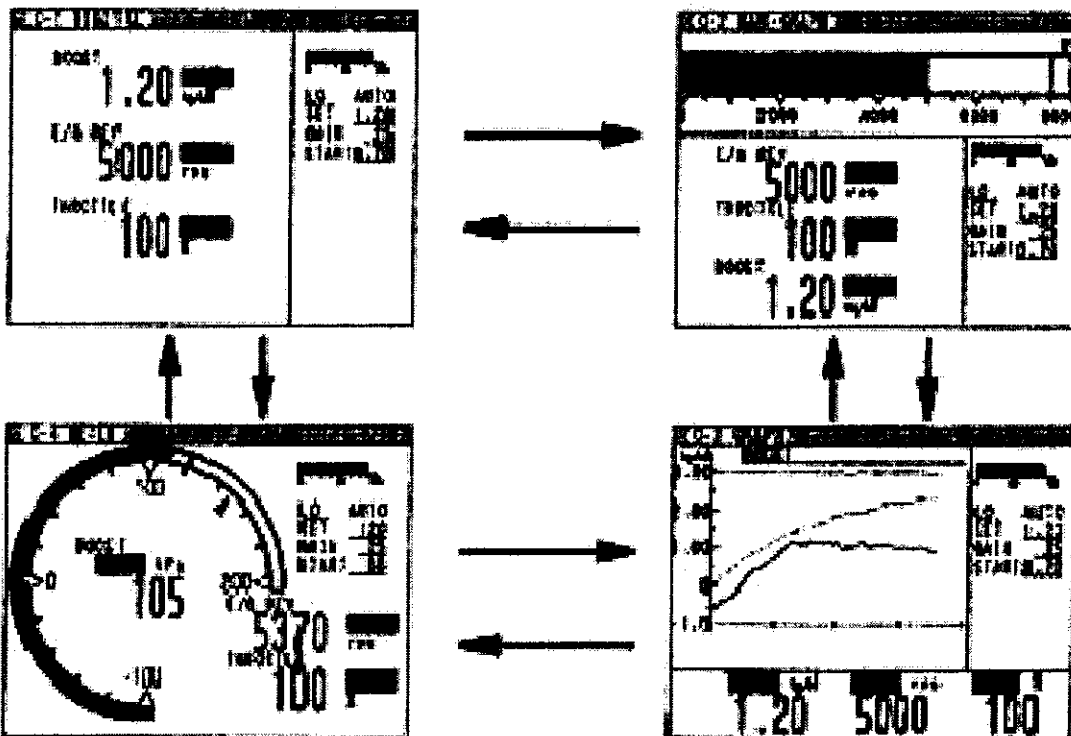

## C DISPLAY

### Recording and Playback Data

All of the input signals can be recorded and played back in the Display or e-manage Map screen mode.

#### 1. Record

3 hours of input signals (Including the e-manage signals) can be recorded while in the Display mode.

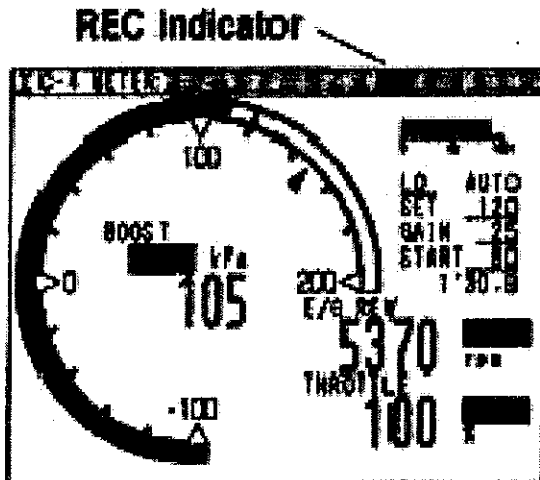

#### How to Record

(1) To start recording, press the down button the 4-way navigation buttons.

When data is being recorded "REC" will appear in the upper right hand corner of the title bar.

(2) Press the down button again to stop.

- This feature will record and play back only 1 set of data.
- Rerecording will over write the previous set of data.

#### Important!

- This feature will only work in the Data Display Mode
- If the cursor is displayed, this feature will not work.

**2. Play Back**

Play back the recorded data in the display mode. If you pause the play back and change the Display mode to e-manage Map display screen, the recorded e-manage data can be played back.

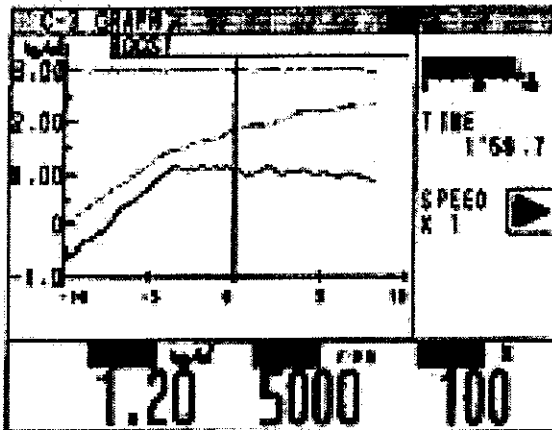

(1) Hold down the SET knob for 2 second to go to Play Back mode.

(2) How to use this feature.



Play / Pause --- Press the Set knob to start



Fast Forward --- Turn the SET knob clockwise.



Reverse ----- Turn the SET knob counter-clockwise.



Stop ----- Press Set knob to stop.

While in Play, turn the SET KNOB to change the sampling speed.

While in Pause, turn the SET KNOB to scroll through the segments.

(3) Hold down the SET knob for 2 second to go back to Display mode.

## C-1 DIGITAL

### Digital Display

CH1~3 data will display in digital format.

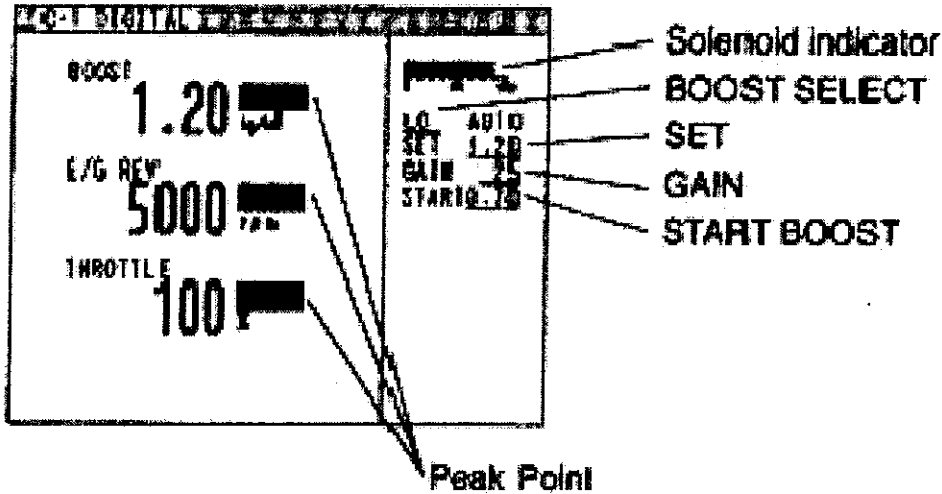

## C-2 BAR-GRAPH

### BAR-Graph Display

CH1~3 data will display in digital format.

CH1 Data will display in Bar Graph format

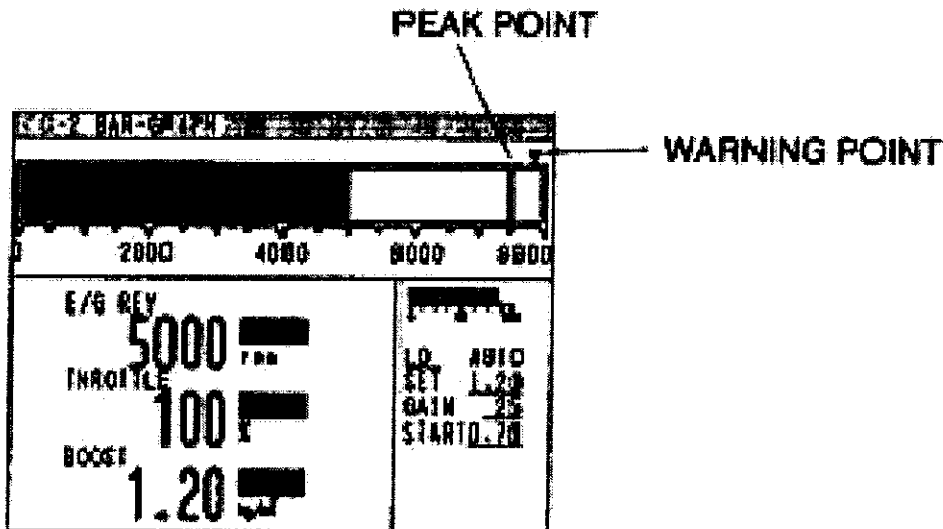

## C-3 GRAPH

### Graph Display

CH1~3 data will display in digital format.

CH 1 will display in Graph format

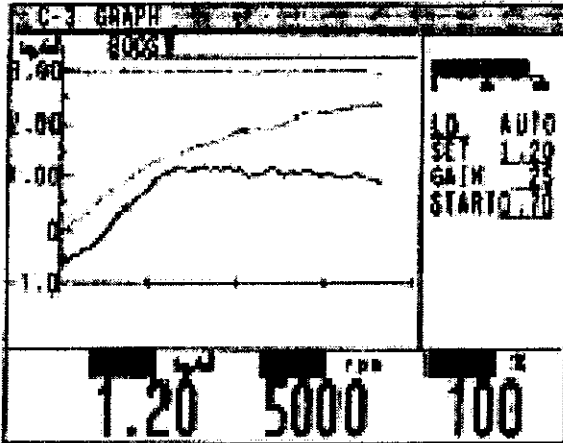

## C-4 METER

### GAUGE Display

CH1~3 data will display in digital format.

CH 1 will display in Gauge format

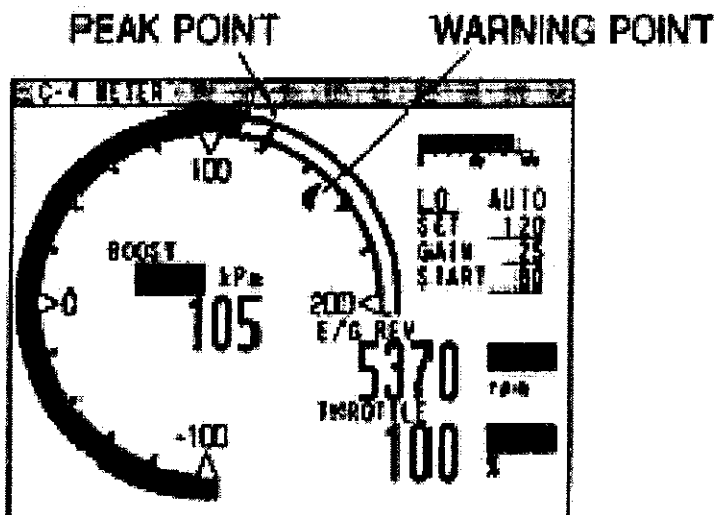



## **e-manage**

Use this feature to tune the e-manage unit by linking with a USB Cable (standard A-B USB available at any computer supply retailer).

### **Initial set up linking with the e-manage**

1. Update the e-manage unit - This will start automatically when links with the e-manage)

See page 31 B-11 PROGRAM

2. Import program from e-manage

See page 52 D-9 IMPORT/EXPORT

3. Set the Parameter

See page 43 D-1 PARAMETER

### **Features:**

- **Air Flow Adjustment Map**  
This: 16 x16 (rpm x throttle position) table is used to fine-tune the input signal of the Air Flow Meter or MAP Sensor to the ECU for fuel enrichment.
- **Upgrade Injectors**  
Controls upgrade injectors. (up to 150% larger than factory)
- **Upgrade Airflow meters**  
Controls upgrade Airflow meters.
- **Boost limiter cut feature**  
Eliminates factory boost limiter.
- **Anti Engine Stall feature**  
This is used to stabilize the rough idle due to turbo compressor surge, Blow-off valve vented out to the atmosphere or use of a high lift camshaft.
- **VTEC® Setting**  
This is used to set the VTEC setting without going in to the Main Unit.
- **Map Trace feature**  
This allows the tuner to pin point the current location on any map table.
- **Security Setting feature**  
This allows the tuner set up a password to apply a security lock to the data in the main unit.

### **Optional Parts:**

- **Harness Kit (Injector control)**  
This harness is used when controlling main injectors or sub injectors
- **Harness Kit (Ignition Timing Control)**  
This Harness is used when controlling the ignition timing.
- **GRReddy Pressure Sensor**  
GRReddy pressure sensor can be used for the scale of each Map table. This is used when the factory system exceeds the Air Flow Meter or MAP sensor capacity.

## D e-manage Operation

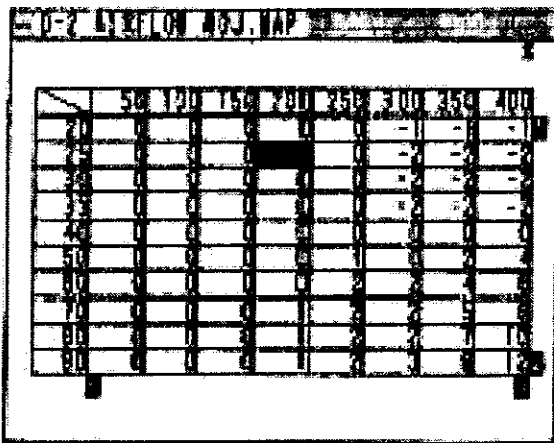

1. Zoom Map screen in and out  
Press SET knob while holding down SHIFT button.



Press SET knob while holding down SHIFT button.

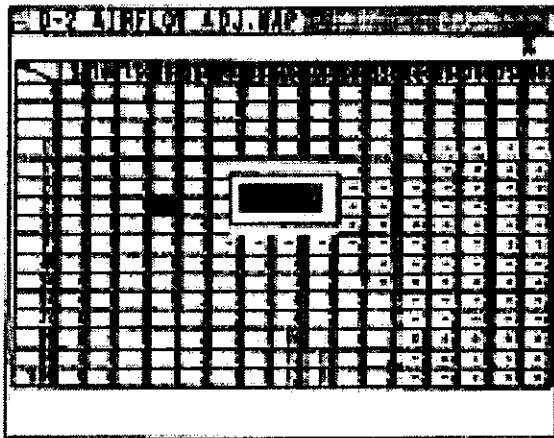

2. Inputting Values  
Move the cursor to the target cell using the 4-way navigation button, and press SET knob to select the cell. Input the value by turning the SET knob or up / down key, and press SET knob to confirm the value.

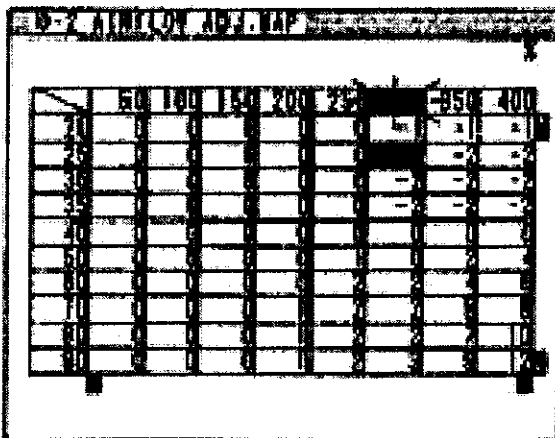

3. Scale Change  
Change the scale of each Map by moving the cursor to the target cell and press SET knob to select the cell. Input the value by turning the SET knob or up / down key, and press SET knob to confirm the value.

# D e-manage Operation

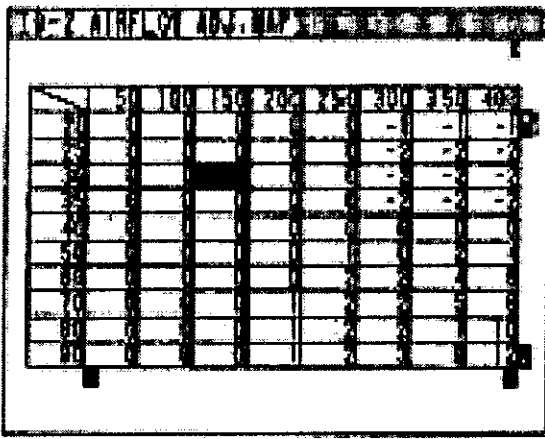

**4. Selecting multiple cells**  
To input a value to a block of cells, highlight the cells by holding down the SHIFT button while moving the cursor with the 4-way navigation button.

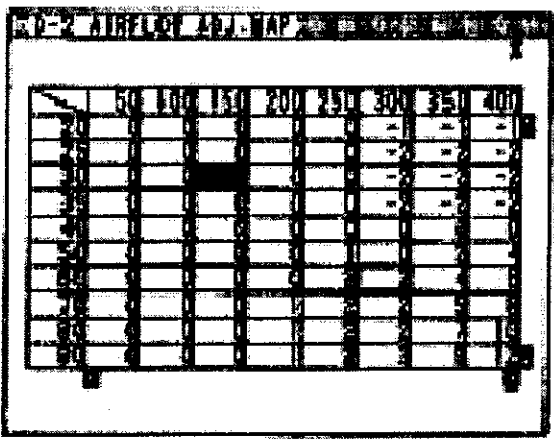
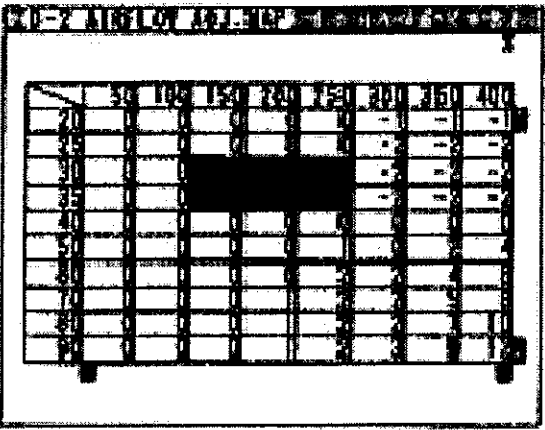

**5. Map Trace**  
This feature will highlight the cell that is currently reading.

## D-1 PARAMETER

This window allows you to change Airflow Meters, injectors, set the Throttle, and select which map to use.

D-1 PARAMETER	
<input checked="" type="checkbox"/> GReddy PR-SENSOR	AIRFLOW CHANGE KS_HR-2
INJECTOR CHANGE Before 300 " + After 500 " = 0.700	
MAP SELECT	
<input type="checkbox"/> IGNITION ADJ. MAP	<input type="checkbox"/> ADD INJECTOR MAP
<input type="checkbox"/> SUB INJECTOR MAP	<input type="checkbox"/> AIRFLOW ADJ. MAP
<input type="checkbox"/> BOOST LIMITER CUT	<input type="checkbox"/> VTEC
<input type="checkbox"/> ANTI ENGINE STALL	
<input type="button" value="ENTER"/> <input type="button" value="CANCEL"/>	

### 1. GReddy PR.SENSOR

Choose this box when an optional GReddy pressure sensor will be used for the scale of each Map tables.

- This function is used when the system exceeds the Air Flow Meter's capacity. The factory ECU will continue to read off the Air Flow Meter, but the e-Manage system will work off the GReddy pressure sensor.

### 2. AIRFLOW CHANGE

- When the Airflow meter or MAP sensor is upgraded, check the Sensor Type from the "Vehicle Specific ECU wire location chart", and select it from the pull down menu.
- The Airflow Type programmed with the Main unit's rotary switch will display as "Main Unit Setting" in the pull down menu.

#### Important!

- When the airflow meter is upgraded, the airflow signal value will change. Make sure to check Air/Fuel Ratio with a proper equipment to ensure proper fuel mixture.

### 3. Injector Change

- When upgrading the injectors, this feature calculates the difference of the two sizes and trims the whole fuel map (factory map) for proper idling and drivability.
- Input the factory injector size and the upgrade injector size.
- This system can control up to 150% larger injectors than the factory. Too large of an injectors can cause problems performing properly.
- When the injectors are upgraded, the injector signal value is being altered. Make sure to check the Air/Fuel Ratio with a proper equipment to ensure proper fuel mixture.

## **D-1. PARAMETER**

### **4. Map Select**

Place check marks on the features you need to program.

#### **IGNITION MAP**

- This allows the tuner to adjust the factory ignition timing.

#### **ADD INJECTOR MAP**

- This is used to increase the factory injector's fuel injection by adding to the factory programmed injector duty cycle.

#### **SUB INJECTOR MAP**

- This feature can be used if the application requires more fuel than the main injectors can provide.

#### **AIRFLOW MAP**

- This is used to adjust the input signal of the Air Flow Meter or MAP Sensor to the ECU for fuel enrichment.

#### **BOOST LIMITER CUT**

- This is used to eliminate the factory fuel cut by ECU due to the increase of the intake air flow.

#### **VTEC**

- This is used to set the VTEC setting without going in to the e-manage Unit.

#### **ANTI ENGINE STALL**

- This feature is used to stabilize the rough idle due to the turbo compressor surge, blow-off valve vented out to the atmosphere or use of a high lift camshaft.

### **5. Confirm settings**

Once all of the settings in the Parameter Setting is complete, click on "Confirm" to send the data to the e-manage unit.

### **6. Cancel**

This will cancel any changes and return back to the e-manage sub menu.

## D-2 AIRFLOW ADJ. MAP

### Airflow Adjustment Setting

- This is used to adjust the input signal of the Air Flow Meter or MAP Sensor to the ECU for fuel enrichment.
- This setting will add to the Air-Flow Adjust Volume (A.A.V) RPM Setup on the main unit.
- Input a negative value to take away fuel.
- When programming the Air Flow Adjustment Map with this unit, it is recommended to set all of the Air Flow Adjust Volume (A.A.V) RPM Setup on the Main Unit to "ZERO".
- Since this is a "piggy back" system, a "zero" value inputted in any map table will be same as the factory ECU setting, and any value other than "zero" is the adjustment to the factory ECU signals or program.

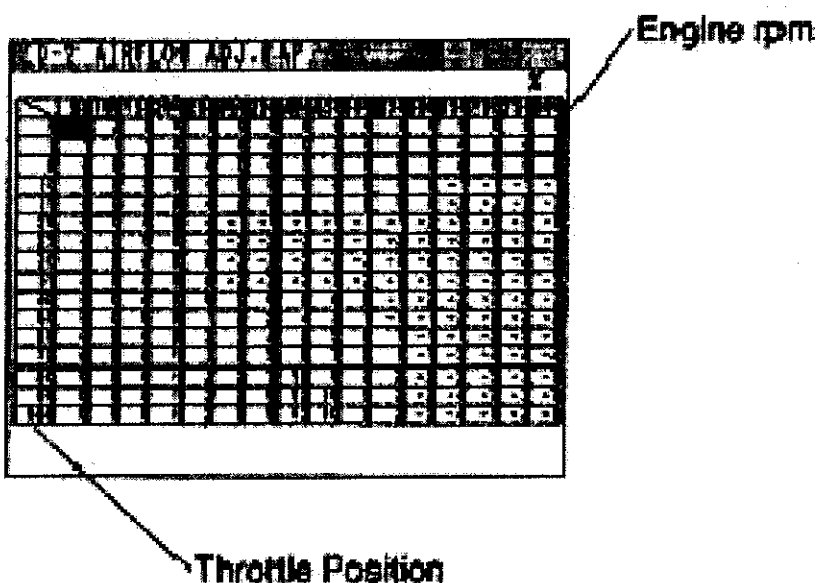

Adjustment Value: %

Input range : -50 ~ +50%, 0.5% increments

### Important

To use this feature the THROTTLE Setting is required.

See Page 27

When a substantial adjustment is made, the ignition timing can be change as well. Make sure to check the air/fuel ratio with proper equipment to prevent any detonation.

# D-3 IGNITION MAP

## Ignition Adjustment Map

This allows the tuner to adjust the factory ignition timing.

- Since this is a "piggy back" system, a "0" value inputted in any map table will be same as the factory ECU setting, and any value other than "zero" is the adjustment to the factory ECU signals or program.
- Input a number for advancing and "-" before the number for retarding the timing.
- The value inputted in this map table is not the actual ignition timing.

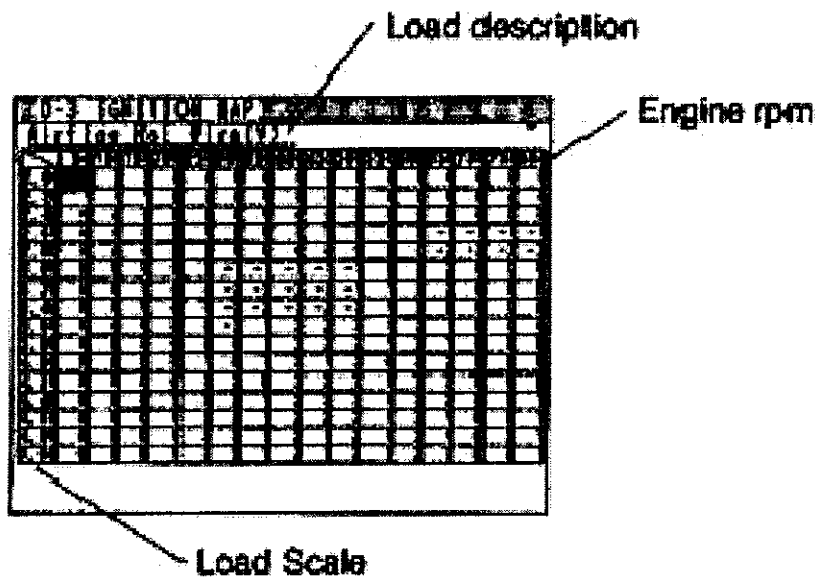

Adjustment Value: °  
Input range : -20 ~ +20°, 1° increments

**Important**

- Since the e-Manage does not receive the crank angle sensor signal, there is a possibility that the timing could be off by  $\pm 1^\circ$ .

## D-4 ADD. INJECTOR MAP

### Additional Injection Setting

- This is used to increase the factory injector's fuel injection by adding to the factory programmed injector duty cycle.
- This feature is required if Boost Limiter Cut feature is used.
- The additional range is 0-100%. However, the duty cycle of the injector cannot exceed 100%.
- Since this is a "piggy back" system, a "0" value inputted in any map table will be same as the factory ECU setting, and any value other than "zero" is the adjustment to the factory ECU signals or program.

### -Example-

If factory ECU injector duty cycle is 50%, and 30% was inputted in this Additional Injection Map.

$$50 + (50 \times 0.3) = 65\%$$

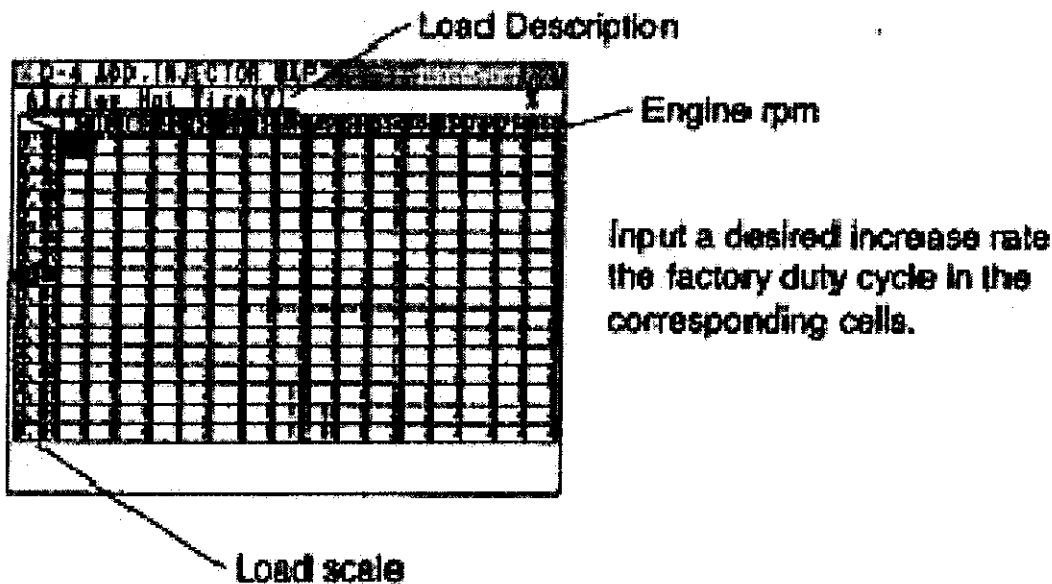

Adjustment Value: %

Input range : 0 -- +100%, 0.5% increments

### Please

- To take out fuel, make the adjustment in the Air Flow Adjustment Map.



## D-6 BOOST LIMITER CUT

### Boost Limiter Cut Setting

- This is used to eliminate the factory fuel cut by ECU due to the increase of the intake air flow.
- The Air Flow Meter or MAP sensor input signal to the ECU can be clamped. However, since ECU can not recognize the amount of increase of the intake air flow over the clamped signal, compensation (increased fuel) in the Additional Injector Map is recommended.

D-6 BOOST LIMITER CUT										
rpm	50	100	150	200	250	300	350	400		
CLAMP	0.005	0.005	0.005	0.005	0.005	0.005	0.005	0.005		
rpm	450	500	550	600	650	700	750	800		
CLAMP	0.005	0.005	0.005	0.005	0.005	0.005	0.005	0.005		

1. In the data recording feature, record the rpm point and air flow meter/MAP sensor voltage and injector duty cycle where the boost limit occurred.
2. Input the clamping value. Input a value slightly lower than the point where injector duty cycle becomes 0% in the data.

rpm:

Input range: 0 ~ 10000rpm, 100rpm increments

Clamp Value: This will automatically change according to the sensor type.

Input range: 0 ~ 5V, 0.05V increments (Air Flow, or MAP type:V)

Input range: 0 ~ 3150Hz, 50Hz increments (Kaman type :Hz)

- This feature is not used for the vehicles that does not have a boost limiter.

# D-5 SUB INJECTOR MAP

## Sub Injector Setting

- o This feature can be used if the application requires more fuel than the main injectors can provide.
- o This feature will drive additional sub-injectors once every two rpm signal pulse. (For 4 cyl., twice every two rev., and for 6cyl., three times every two rev.)
- o Either injector duty cycle or duration can be selected as the numerical value in Map table.
- o The injector duty cycle range is 0-100%
- o A value higher than 95% entered will be displayed in RED.

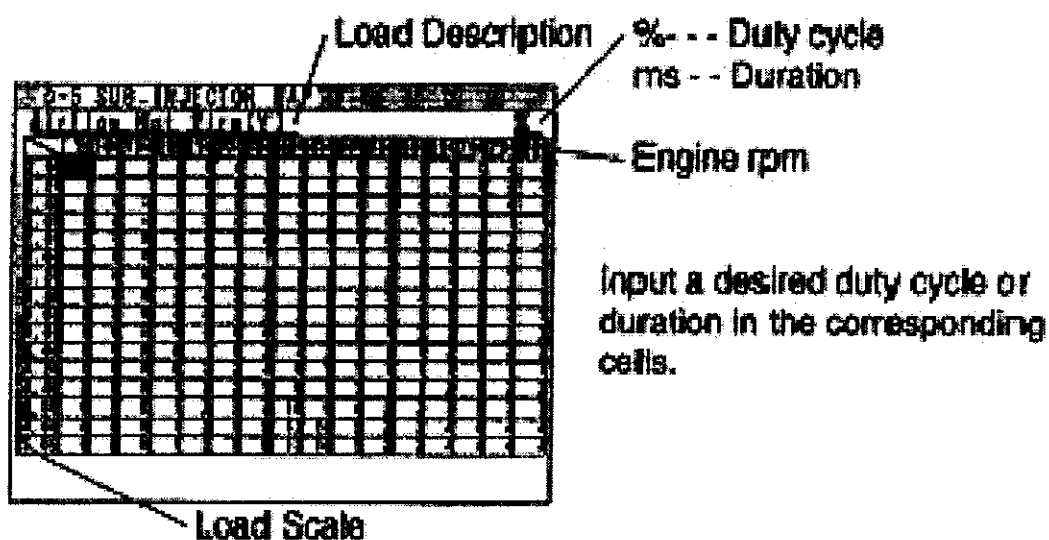

**Adjustment Value: %**  
**Input range : 0 ~ +100%, 0.5% increments**

# D-7 ANTI ENGINE STALL

## Anti Engine Stall Setting

- This feature is used to stabilize the rough idle due to the turbo compressor surge, blow-off valve vented out to the atmosphere or use of a high lift camshaft.
- Input the Throttle Position in degrees. This will allow the values below the inputted value (throttle opening) to be recognized as accelerator OFF (fully closed).
- The Airflow Meter or MAP sensor input signal to the ECU can be clamped at a desired voltage at 8 different rpm points to prevent engine stall or rough idle.

RPM	50	100	150	200	250	300	350	400	450
CLAMP	0.005	0.005	0.005	0.005	0.005	0.005	0.005	0.005	0.005

1. In the data record feature, record the rpm point, airflow meter/MAP sensor voltage and injector duty cycle where the engine stalls.
2. Input the rpm points where the airflow voltage fluctuates and input the airflow clamping value.

**Throttle Position: %**  
Input range : 0 ~ 10%, 1% increments

**rpm:**  
Input range: 0 ~ 8000rpm, 50rpm increments

**Clamp Value:** This will automatically change according to the airflow type.  
Input range: 0 ~ 5V, 0.05V increments (Air Flow, or MAP type:V)  
Input range: 0 ~ 3150Hz, 50Hz increments (Karman type :Hz)

- This feature is not needed for vehicles that do not have any engine stalling problems.

## D-8 VTEC

### VTEC Setting

This is used to set the VTEC setting without going in to the Main Unit. The VTEC setting with e-01 will over ride the setting on the e-manage Unit.

D-8 VTEC	
VTEC SHIFT POINT	
LO → HI	1500 RPM
HI → LO	4500 RPM
AIRFLOW ADJUSTMENT	20 %

#### 1. VTEC SHIFT POINT

- Lo->Hi - - - VTEC turns on.
- Hi->Lo - - - VTEC turns off.

#### 2. AIRFLOW ADJUSTMENT

When the VTEC shift point is changed from factory setting, the airflow will need to be adjusted for proper air/fuel ratio.

rpm:

Input range: 1500 ~ 7000rpm, 50rpm increments

Adjustment Value: %

Input range : -20 ~ +20%, 1% increments

Input range : 0 ~ 100%, 0.5% increments

# DATA IMPORT / EXPORT

## DATA IMPORT / EXPORT

This feature is used to program to and from the e-manage.

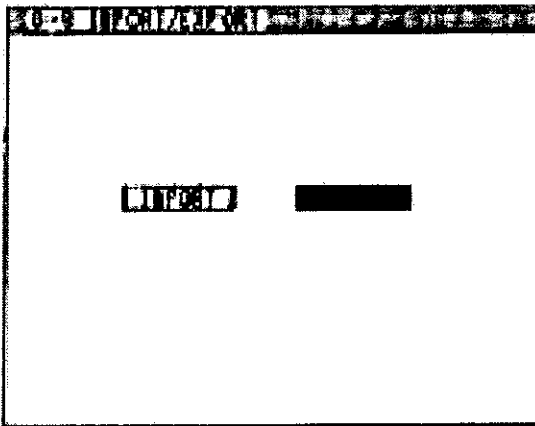

1. Import Used to Import the data from the Main Unit.
2. Export Used to export all the data to the Main Unit.

When the e-01 and e-manage is linked, they are communicating at real time. When a setting is changed, it will send it to e-manage automatically.



When an error occurs, re-import or reexport the program.

# DATA LOAD / SAVE

This feature is used to save and load data to and from the SD memory card.

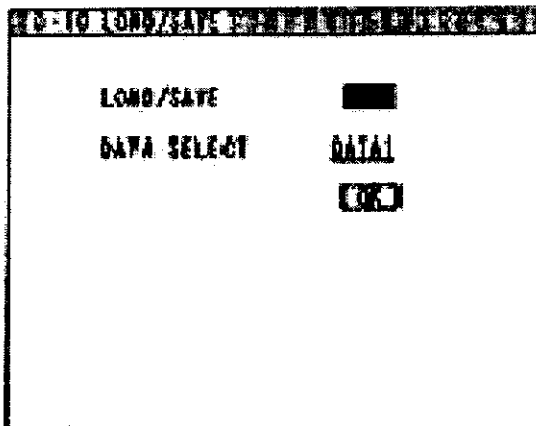

## 1. LOAD / SAVE

**LOAD** --- Loads the saved data from the SD card.

**SAVE** --- Saves the data to SD card.

## 2. DATA SELECT

Select the data to load or save. SD card can save up to 3 data.

**Important!**  
If a new data is loaded, it must be exported to the e-manage unit.

## D-11 INITIALIZE

This will reset all of the e-manage settings.

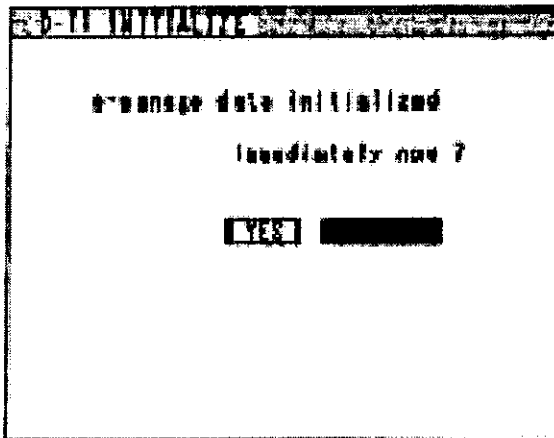

To reset the e-01 settings, see page 31 B-12 INITIALIZE

## D-12 PASSWORD

This allows the tuner set up password to apply security lock to the data in the main unit.

It will require the tuner to input a password to communicate with the main unit.

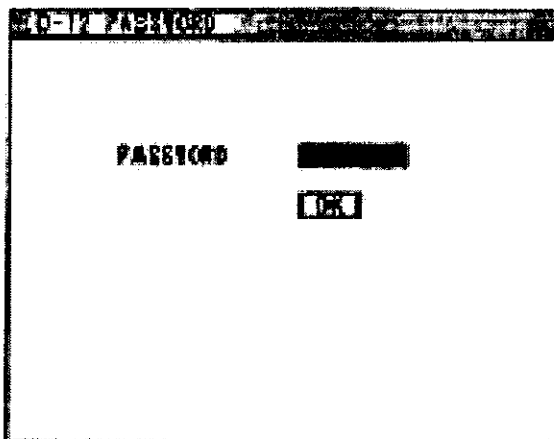

### To Lock

Input a pass word and click on OK.

### To unlock

Input a pass word and click on OK.

### Important!

To clear the stored password, the e-manage setting must be re-initialized.

Re-initializing will clear all the e-manage.

## 7. e-manage ERROR CODES

CODE	Error Error	Description
20	No injector pulse from all	Not receiving an injector signal
21	No injector 1 pulse	Not receiving injector signal I/J CH-1
22	No injector 2 pulse	Not receiving injector signal I/J CH-2
23	No injector 3 pulse	Not receiving injector signal I/J CH-3
24	No injector 4 pulse	Not receiving injector signal I/J CH-4
25	No injector 5 pulse	Not receiving injector signal I/J CH-5
26	No injector 6 pulse	Not receiving injector signal I/J CH-6
27	No injector A pulse	Not receiving injector signal I/J CH-A
28	No injector B pulse	Not receiving signal I/J CH-B
31	Incorrect injector 1 pulse	Incorrect I/J CH-1 wire to e-Manage
32	Incorrect injector 2 pulse	Incorrect I/J CH-2 wire to e-Manage
33	Incorrect injector 3 pulse	Incorrect I/J CH-3 wire to e-Manage
34	Incorrect injector 4 pulse	Incorrect I/J CH-4 wire to e-Manage
35	Incorrect injector 5 pulse	Incorrect I/J CH-5 wire to e-Manage
36	Incorrect injector 6 pulse	Incorrect I/J CH-6 wire to e-Manage
37	Incorrect injector A pulse	Incorrect I/J CH-A wire to e-Manage
38	Incorrect injector B pulse	Incorrect I/J CH-B wire to e-Manage
40	NG order of Ign. signal	Incorrect wiring order of the Ignition signal
41	No Ignition Signal 1 pulse	Not receiving the Ignition signal IG CH-1
42	No Ignition Signal 2 pulse	Not receiving the Ignition signal IG CH-2
43	No Ignition Signal 3 pulse	Not receiving the Ignition signal IG CH-3
44	No Ignition Signal 4 pulse	Not receiving the Ignition signal IG CH-4
45	No Ignition Signal 5 pulse	Not receiving the Ignition signal IG CH-5
46	No Ignition Signal 6 pulse	Not receiving the Ignition signal IG CH-6
47	JP1 PULL UP error	Incorrect Jumper setting (JP1)
48	JP1 PULL DOWN error	Incorrect Jumper setting (JP1)
49	No Ignition pulse	Not receiving the Ignition signal
51	Incorrect Ignition 1 pulse	Incorrect IG CH-1 wire to e-Manage
52	Incorrect Ignition 2 pulse	Incorrect IG CH-2 wire to e-Manage
53	Incorrect Ignition 3 pulse	Incorrect IG CH-3 wire to e-Manage
54	Incorrect Ignition 4 pulse	Incorrect IG CH-4 wire to e-Manage
55	Incorrect Ignition 5 pulse	Incorrect IG CH-5 wire to e-Manage
56	Incorrect Ignition 6 pulse	Incorrect IG CH-6 wire to e-Manage
57	JP2 + 12V error	Incorrect Jumper setting (JP2)